

Nikon

N6000

INSTRUCTION MANUAL

CONTENTS

FOREWORD	3	PROGRAMMED (P_M AND P) AUTO	36 - 38
NOMENCLATURE	4 - 8	FLEXIBLE PROGRAM	38
BASIC OPERATION	9 - 20	SHUTTER-PRIORITY AUTO EXPOSURE	
MOUNTING THE LENS	10	MODE	39 - 41
INSTALLING BATTERY	11	OPERATION IN SHUTTER-PRIORITY	
CHECKING BATTERY POWER	12	AUTO EXPOSURE MODE	40 - 41
LOADING FILM	13 - 15	APERTURE-PRIORITY AUTO EXPOSURE	
BASIC SHOOTING	16 - 19	MODE	42 - 44
REWINDING FILM	19 - 20	OPERATION IN APERTURE-PRIORITY	
CONTROLS IN DETAIL/PHOTOGRAPHIC		AUTO EXPOSURE MODE	43 - 44
TECHNIQUES	21 - 60	MANUAL EXPOSURE MODE	45 - 49
FILM SPEED SETTING	22 - 24	OPERATION IN MANUAL EXPOSURE MODE	45 - 47
USING AUTOMATIC FILM SPEED SETTING FOR		TO GET EXPOSURE METER READING	
DX-CODED FILMS	22 - 23	FOR A MAIN SUBJECT OFF CENTER	48 - 49
MANUAL FILM SPEED SETTING	23 - 24	BULB SETTING	49
FILM ADVANCE MODE SETTING	25	EXPOSURE COMPENSATION	50 - 58
SINGLE-FRAME SHOOTING	25	AE (AUTO EXPOSURE) LOCK LEVER	50 - 51
CONTINUOUS SHOOTING	25	EXPOSURE COMPENSATION BUTTON	52 - 53
FOCUSING	26 - 27	AUTO EXPOSURE BRACKETING	54 - 58
EXPOSURE	28 - 58	SELF-TIMER OPERATION	59 - 60
EXPOSURE METERING SYSTEMS	28 - 33	ONE-SHOT SELF-TIMER	59
MATRIX METERING	28	TWO-SHOT SELF-TIMER	60
CENTER-WEIGHTED METERING	28	ACCESSORIES	61 - 70
METERING SYSTEM SETTING	29	LENS COMPATIBILITY	62 - 63
METERING SYSTEM SELECTION -		ACCESSORIES	64 - 70
WHEN TO USE MATRIX OR		OPTIONAL SPEEDLIGHTS	64
CENTER-WEIGHTED METERING	30 - 33	CLOSE-UP ACCESSORIES	65 - 67
EXPOSURE MODE	34 - 49	VIEWING ACCESSORIES	67
EXPOSURE MODE SETTING	35 - 36	OTHER ACCESSORIES	68 - 70

<i>MISCELLANEOUS</i>	71 - 83
CAMERA CARE TIPS	72 - 73
NOTES ON BATTERIES	74
SPECIFICATIONS	75 - 77
GLOSSARY	78 - 80
WARNING INDICATIONS	81 - 83

FOREWORD

Thank you for purchasing the Nikon N6000. We hope you enjoy using this camera. We know it will make photography a bigger part of your life.

Before using the N6000, read this manual, as well as the supplementary section on "FLASH PHOTOGRAPHY."

NOMENCLATURE

Film plane indicator: Exact distance from lens mounting flange to film plane is 46.5mm.

Accessory shoe: Accepts Nikon-dedicated Speedlights.

LCD panel: See page 8.

Power switch

Self-timer indicator LED:
See pages 59 to 60.

Release terminal: Accepts optional Nikon Cable Release AR-3 or Double Cable Release AR-7.

Shutter release button

Minimum aperture lock: Lock for programmed auto or shutter-priority auto exposure mode.

Aperture scale

Camera strap eyelet

Lens mounting index

Lens release button

Aperture ring

Focusing ring

**Lens (AF Zoom-Nikkor
35-70mm f/3.3-4.5)**

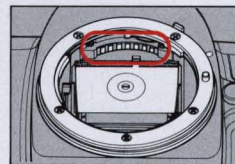

CPU contacts: Do not touch.

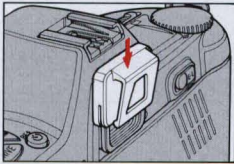

Eyepiece cover DK-5 (provided): Prevents stray light from entering viewfinder.

AE (Auto Exposure) lock lever: See pages 50 to 51.

Viewfinder eyepiece

Camera back

Film cartridge confirmation window

Camera back lock release:
Push down to open camera back.

Film rewind button: Press while sliding lever.

Film rewind lever: Slide in the direction of the arrow.

Battery chamber cover lock release

Tripod socket

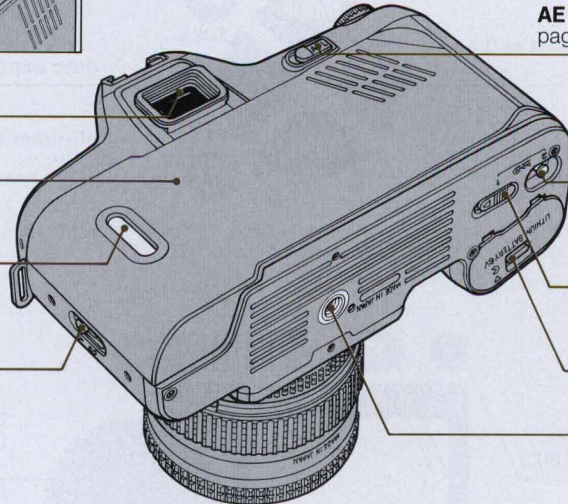

Exposure mode (MODE) button/Automatic
Balanced Fill-Flash () button

Metering system () button/Slow sync
button

Film speed (ISO) button/Film speed setting
mode (DX/M) button

Auto exposure bracketing (BKT) button

Film advance mode (DRIVE) button

Self-timer () button/Rear-Curtain sync
button

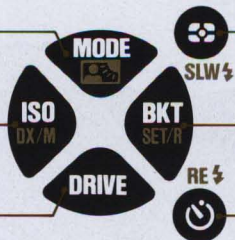

These buttons are used with the command dial or shift button.
For function of each button, see next page.

Shift button: Press to set the functions
shown in matte gold  on camera body.



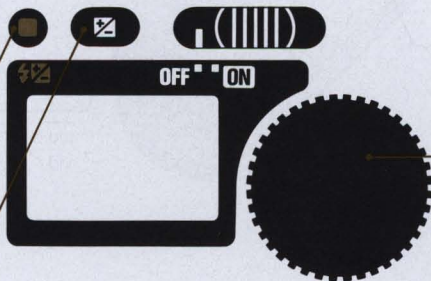

Exposure compensation button



**Command input control dial
(Command dial):** Can be rotated
to set various functions.

Command dial/shift button functions

Combined with buttons listed below, the command dial and shift button provide various functions.

Button	With Command Dial	With Shift Button
Metering system ()/Slow sync button	To select metering system, rotate dial while pressing this button. (See page 29)	With shift button pressed, this button is used to set/cancel slow sync for flash photography.
Exposure mode (MODE)* /Automatic Balanced Fill-Flash () button	To select exposure mode, rotate dial while pressing this button. (See page 35)	With shift button pressed, this button is used to set/cancel automatic balanced Fill-Flash for flash photography.
Film speed (ISO) button/Film speed setting mode (DX/M) button	To manually set film speed, rotate dial while pressing this button. (See pages 23 to 24)	With shift button pressed, this button is used to set film speed (auto for DX-coded film or manual, see page 22)
Film advance mode (DRIVE) button*	To set film advance mode, rotate dial while pressing this button. (See page 25)	—
Exposure compensation () button	To make exposure compensation, rotate dial while pressing this button. (See pages 52 to 53)	—
Auto exposure bracketing (BKT) button	See pages 54 to 58.	
Self-timer ()/Rear-curtain sync button	Rotate it to set self-timer operation. (See pages 59 to 60)	With shift button pressed, this button is used to set/cancel rear-curtain sync for flash photography.
—	With shift button pressed, rotate command dial for flash output level compensation. For details, see pages 35 to 37 on "FLASH PHOTOGRAPHY", a separate instruction book.	

*Pushing MODE and DRIVE buttons simultaneously for more than one second sets N6000 for basic shooting.

In the following cases, command dial can be used by itself.

In Programmed auto exposure mode	Turn command dial for flexible program
In Shutter-Priority auto or Manual exposure mode	Turn command dial to set shutter speed

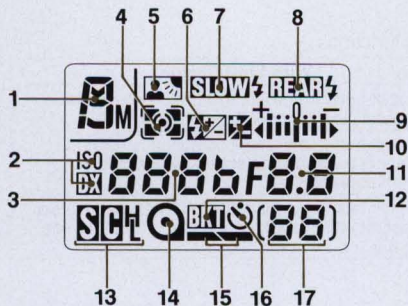

LCD panel indications

1. Exposure mode
2. Film speed setting mode
3. Shutter speed/film speed (for manual film speed setting)/number of frames for auto exposure bracketing
4. Metering system
5. Automatic Balanced Fill-Flash
6. Flash output compensation
7. Slow flash sync
8. Rear-curtain sync
9. Electronic analog display
10. Exposure compensation
11. Aperture/exposure compensation value
12. Auto exposure bracketing
13. Film advance mode
14. Film loading
15. Film advance and rewind
16. Self-timer
17. Frame counter/number of remaining frames for auto exposure bracketing/self-timer duration

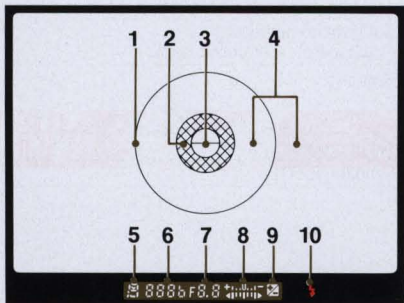

Viewfinder indications

1. 12mm-dia. central area
2. Microprism collar
3. Split-image rangefinder
4. Clear matte field
5. Exposure mode
6. Shutter speed/film speed (for manual film speed setting)/number of frames for auto exposure bracketing
7. Aperture/exposure compensation value
8. Electronic analog display
9. Exposure compensation
10. Ready-light LED

BASIC OPERATION



MOUNTING THE LENS

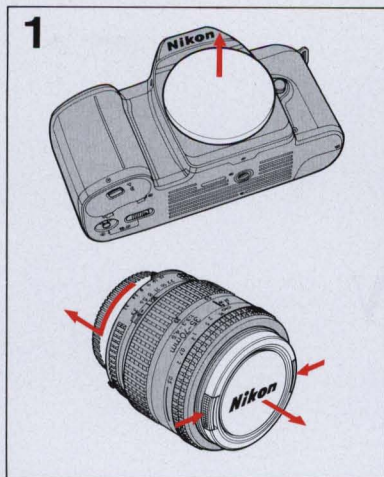

Remove camera body cap and front and rear lens caps.

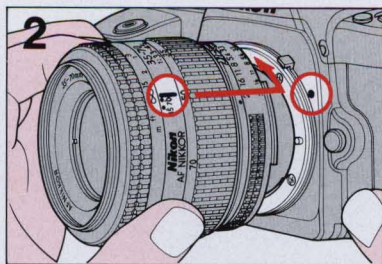

Aligning lens mounting index on the camera body with lens' aperture index, twist lens counterclockwise until it locks securely into place.

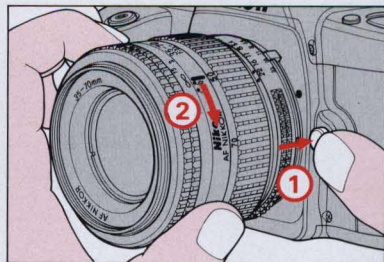

To remove

Push lens release button and turn lens clockwise.

See page 62 for Nikon lens compatibility chart.

INSTALLING BATTERY

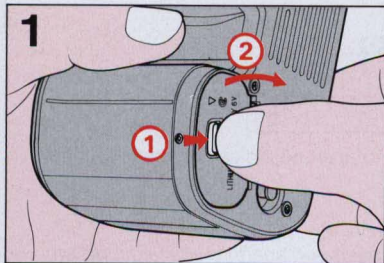

Open battery chamber cover by sliding the lock release.

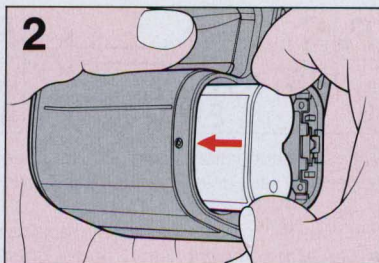

Insert 6V lithium battery pack (Duracell DL 223A, Panasonic CR-P2 or equivalent) with "+" and "-" ends positioned as shown on the inside cover. Then push the battery pack down until it locks into place.

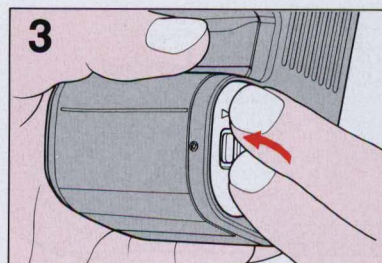

Close the cover by pushing until it clicks.

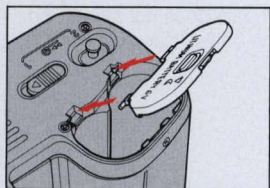

The battery chamber cover may be detached if pressure is applied. This prevents it from being broken. If the cover is accidentally detached, simply reattach it as illustrated, making sure to push it until it clicks into place.

See page 74 for "NOTES ON BATTERIES."

CHECKING BATTERY POWER

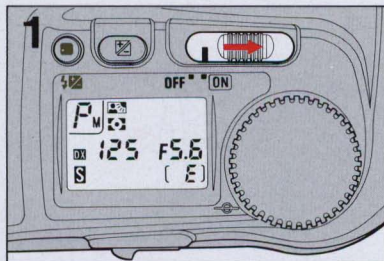

Slide power switch to ON and confirm indications on LCD panel.

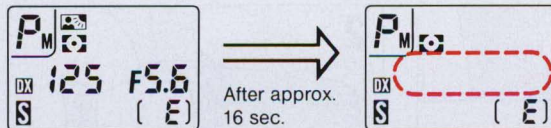

With sufficient battery power, shutter speed and aperture indicators remain on for approx. 16 sec., unless you release shutter.

If indicators turn off immediately, replace battery.

- Even with sufficient battery power, shutter speed and aperture indicators go off approx. 2 sec. after you remove your finger from button, following shutter release.
- Lightly pressing the shutter release button, after exposure meter automatically turns off, turns exposure meter on again. With sufficient battery power, meter stays on for approx. 16 sec. after you remove your finger from the shutter release button.

- When not using the camera, be sure to turn power switch off, to conserve battery power.
- The battery operates camera motor. When film-advance speed becomes noticeably slower, replace battery with fresh one.
- If all indicators on LCD panel blink when you lightly press shutter release button, battery should be replaced.
- If shutter does not operate and data does not appear on the LCD panel or viewfinder, the battery pack is exhausted or improperly loaded.

LOADING FILM

To avoid fogging film (especially high-ISO film), do not load/unload film in direct sunlight.

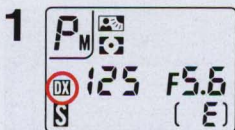

Confirm whether **DX** for auto setting is shown on the LCD panel.

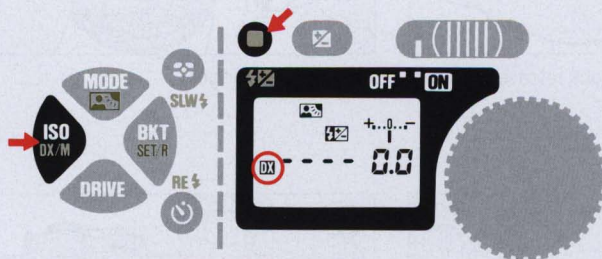

If not, press and hold shift button, then press ISO button so **DX** appears.

- Usable film speed range for DX-coded films is ISO 25 to 5000.
- For details about film-speed setting including manual film speed setting, see pages 23 to 24.

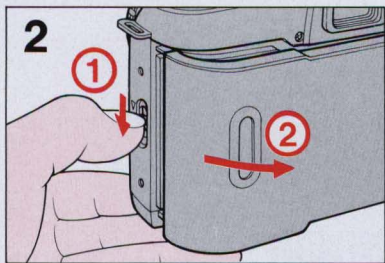

Slide camera back lock release to open camera back.

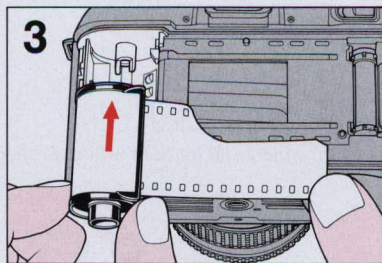

Insert film cartridge.



Do not touch shutter curtains with your finger or with film leader.

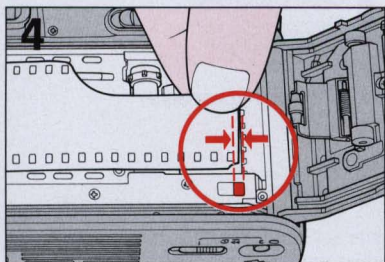

Pull film leader out to red index mark.

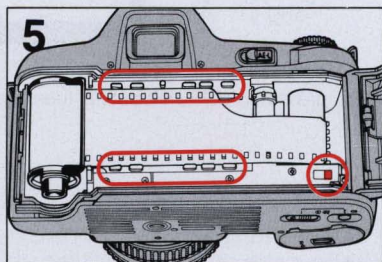

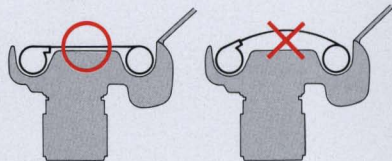

Check to ensure film is properly positioned with no slack. (See illustration)

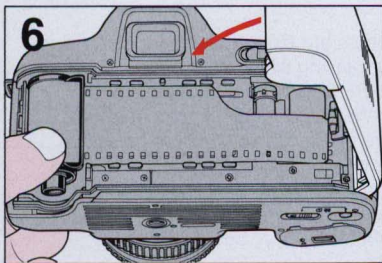

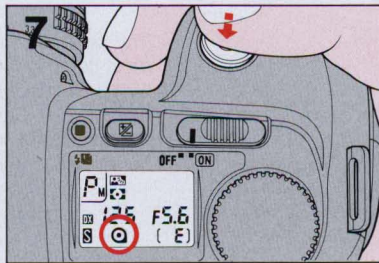

6 Close camera back until lock release snaps closed.



7 Lightly press shutter release button to confirm film installation symbol  appears in LCD panel. Frame counter shows "E" for "Empty."

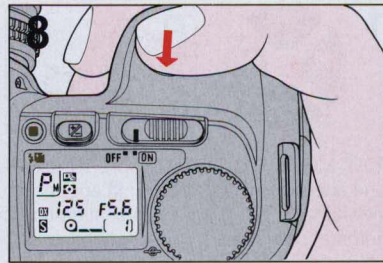

8 Fully depress shutter release button to automatically advance film to frame 1.

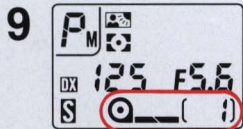

9 Confirm frame "1" and  symbol appear on LCD panel.

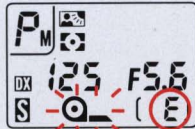

• If film is not correctly positioned, "E" remains,  symbol blinks and shutter locks. Open camera back and reload film.

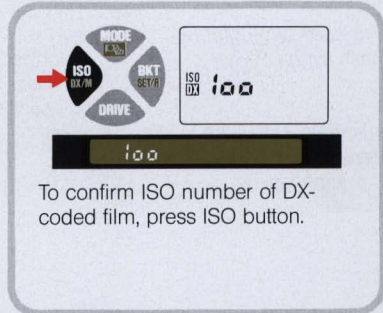



To confirm ISO number of DX-coded film, press ISO button.

BASIC SHOOTING

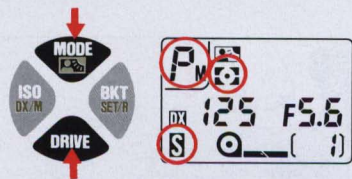
1



Push MODE and DRIVE buttons simultaneously for more than one second until **P**,  and **S** appear on the LCD panel (while viewfinder LCD shows P), indicating that camera settings are automatically reset for basic shooting as shown below:

Film advance	Single frame (S)
Metering system	Matrix ()
Exposure control	Auto Multi-Program (P)
Flexible program setting	Cancel
Exposure compensation on camera	± 0
Auto exposure bracketing	Not set
<i>(For flash photography)</i>	
Flash sync	Normal – Slow sync and Rear curtain sync cancelled
Automatic Balanced Fill-Flash	Set
Manual flash light output compensation	± 0

The settings shown here are basic settings for the easiest, most common picture-taking situations using lenses with a CPU (such as AF Nikkor or AI-P lenses). With other lenses, Center-Weighted metering and Aperture-Priority auto exposure mode are automatically selected. For detailed information, see following pages.

For film advance mode	See page 25
For metering system	See pp 28 - 33
For exposure control	See pp 34 - 49
For flexible program	See page 38
For exposure compensation with button	See pp 52 - 53
For auto exposure bracketing	See pp 54 - 58
For flash photography	See separate instruction section

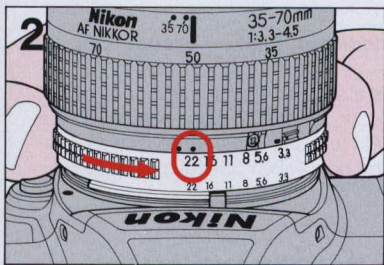

Set lens to its minimum aperture (highest f-number marked in orange on AF Nikkor lenses).

With AF Nikkor or AI-P lenses, lock lens aperture at its minimum setting. (See lens instruction manual)

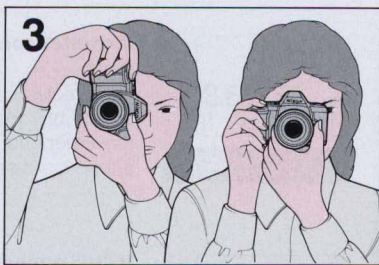

Look through viewfinder while turning focusing ring until the two halves of the split image rangefinder coincide perfectly to form a single unbroken image and the image in the microprism grid appears sharp.

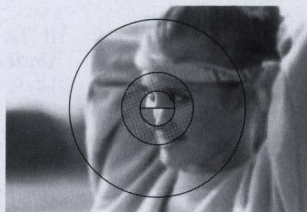
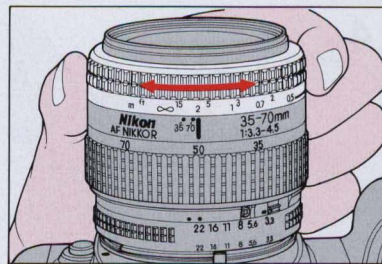

Out of focus

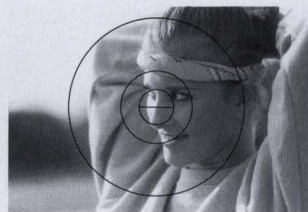

In focus

For details about focusing, refer to pp 26 - 27.

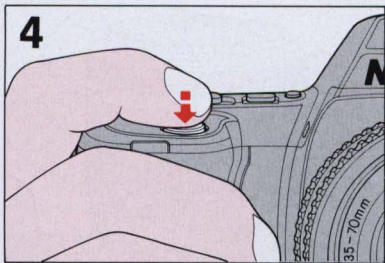

4
Compose picture and lightly press shutter release button to turn meter on.

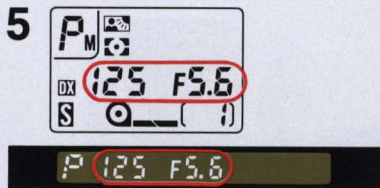

5
Confirm exposure.
When exposure is correct, shutter speed and aperture indicators appear in the viewfinder and on the LCD panel.



If shutter speed indicator blinks – Picture blur alert:

If a selected shutter speed is 1/(focal length) or slower, picture blur may occur due to camera shake or subject movement. To avoid blur, hold camera very steady, use a tripod, or use accessory Nikon Speedlight.

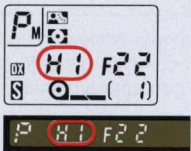

If “HI” appears in the shutter speed position – Overexposure alert:

Overexposure may occur. Use a filter such as the Nikon ND filter.

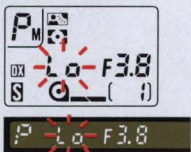

If “Lo” blinks in the shutter speed position – Underexposure alert:

Underexposure may occur. Use a Nikon Speedlight.

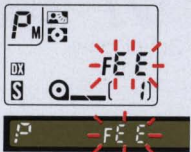

If “FEE” blinks in the aperture position – Lens setting error alert:

Lens is not set to smallest aperture setting and shutter locks. Set lens to smallest aperture.

REWINDING FILM

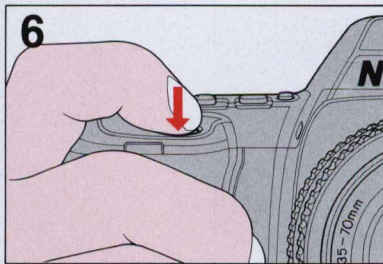

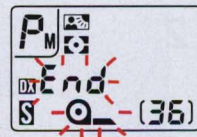
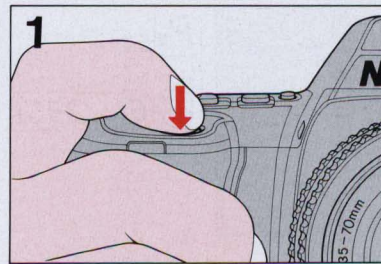

Fully depress shutter release button to take picture. Camera automatically advances film by one frame. LCD panel's frame counter increases by one.

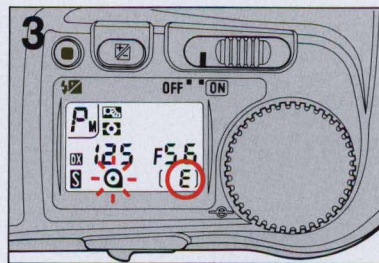
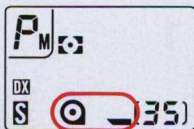
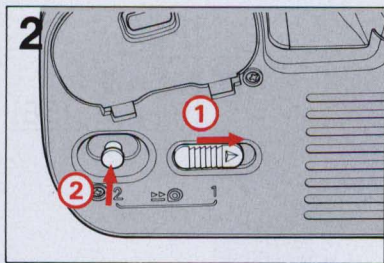

Film advance stops automatically at end of roll. Each time you press shutter release button, **End** and  symbol on the LCD panel blink reminding you to rewind film.

Shutter speed aperture indicators on the LCD panel and inside viewfinder turn off approx. two sec. after you release shutter and remove your finger from shutter release button.



To rewind film, while sliding film rewind lever in the direction of arrow, press film rewind button to start film rewinding. During film rewind,  symbol appears on the LCD panel, and frame counter will count backwards until rewind is complete.

- You can rewind film before it reaches end of roll in the same manner.

- If camera stops during film rewind, replace battery without opening camera back.

After installing battery, turn power switch on, and restart film rewind by the same method as before.

After rewind automatically stops, confirm frame counter shows "E," and film installation symbol () blinks for a few seconds.

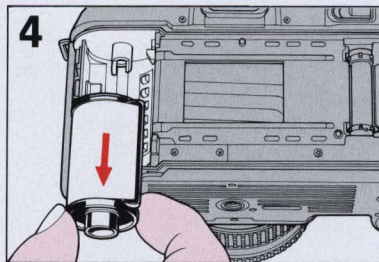

Open camera back and remove film cartridge.

***CONTROLS IN DETAIL/
PHOTOGRAPHIC TECHNIQUES***

FILM SPEED SETTING

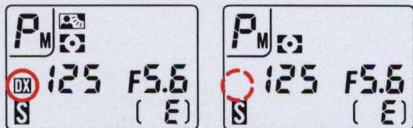

The N6000 offers two ways to set film speed — automatic film speed setting for DX-coded film and manual film speed setting. Each time you press the ISO button, while depressing the shift button, film speed setting changes from auto/DX to manual, or vice versa. The LCD panel shows **DX** for auto; there is no indication for manual.

USING AUTOMATIC FILM SPEED SETTING FOR DX-CODED FILMS

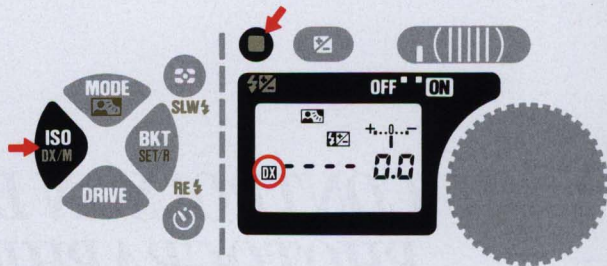

Usable film speed range for DX-coded film is ISO 25 to 5000.

1. Slide power switch to ON.
2. While depressing shift button, press film speed (ISO) button so **DX** is shown in LCD panel.

Camera automatically detects film speed (ISO 25 to 5000) of DX-coded film.



- After loading film, you can confirm speed by pressing ISO button. ISO number will appear in LCD panel and viewfinder.

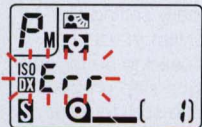

If “Err,” ISO symbol and DX symbol are blinking:

Non-DX-coded film or film with an unacceptable DX code is loaded. Set ISO manually.

MANUAL FILM SPEED SETTING

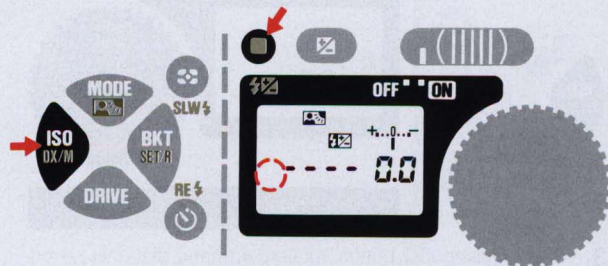

Usable range for manual film speed settings is ISO 6 to 6400.

1. Slide power switch to ON.
2. While depressing shift button, press film speed (ISO) button so that **DX** on the LCD panel disappears.



3. While pressing ISO button, rotate command dial until desired number is shown.

Film speed setting display changes as follows:

6 - 8 - 10 - 12 - 16 - 20 - 25 - 32 - 40 - 50 - 64 - 80 - 100 - 125 - 160 - 200 - 250 - 320 - 400 - 500 - 640 - 800 - 1000 - 1250 - 1600 - 2000 - 2500 - 3200 - 4000 - 5000 - 6400

- *With or without film loaded, you can confirm film speed by pressing ISO button. Manually set ISO number will appear on the LCD panel and viewfinder.*
- *If DX-coded film is loaded, but manual film speed setting is selected, camera gives priority to the manually set ISO number.*

You can modify exposure by intentionally setting film speed to a value different from that of film in use. For example, with ISO 100 film, set film speed to 50 for one step over exposure or set to 200 for one step under-exposure. After taking the picture, make sure to reset film speed. For exposure compensation using other methods, see pp 50 - 58.

FILM ADVANCE MODE SETTING

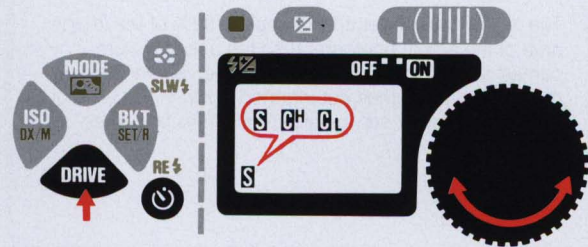

Nikon N6000 has three automatic film-advance modes. To switch film-advance mode, press and hold DRIVE button and rotate command dial. **S** for single-frame shooting, **CL** for continuous low-speed shooting and **CH** for continuous high-speed shooting appear consecutively.

SINGLE-FRAME SHOOTING

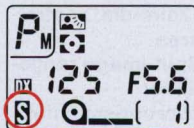

With film advance mode at **S**, fully depressing shutter release button takes one picture and automatically advances film by one frame.

CONTINUOUS SHOOTING

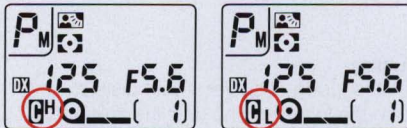

Shots are taken continuously as long as shutter release button is depressed. High- or low-speed continuous shooting can be selected.

Shooting speed is approx. 2 fps (frames per second) in **CH** mode or approx. 1.2 fps in **CL** mode — with a fresh battery pack at normal temperature and a shutter speed faster than 1/125 sec. The slower the shutter speed, the slower the motor speed.

FOCUSING

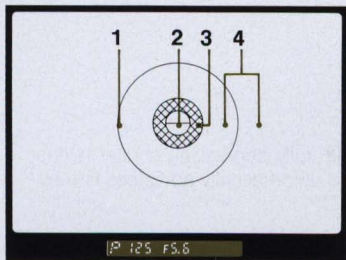

1. 12mm-dia. central area
2. Split-image range-finder
3. Microprism color
4. Matte field

The type K focusing screen that comes with the N6000 has three focusing aids:

A. Split-image focusing

For precise, pinpoint focusing of subjects with distinct edges/contours, turn the focusing ring until the split-image becomes whole.

B. Microprism focusing

For rapid focusing and for subjects with indistinct outlines, turn focusing ring until the shimmering image becomes sharp.

C. Matte-field focusing

For close-up photography at high magnification, or when using a telephoto lens with a maximum aperture of approx. $f/11$ or smaller, the split-image may darken. Turn focusing ring until image on the matte field appears sharp.

The N6000 viewfinder covers approx. 92% of the image area of the actual photograph so the actual picture comes out larger than the image in the viewfinder. Note that the picture comes out trimmed down in the case of mounted slides or service-size prints from negatives.

When using a zoom lens:

For maximum focusing accuracy, focus at the lens' longest focal length setting. The shallow depth of field and large image scale at the longest focal length setting help ensure pinpoint focusing. Conversely, focusing at the shortest focal length setting and then zooming up to the longest focal length setting will magnify any slight imprecision in focusing and could result in unsharp pictures.

A. Split-image focusing

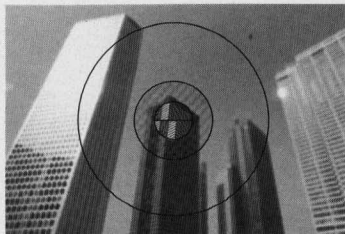

Out of focus

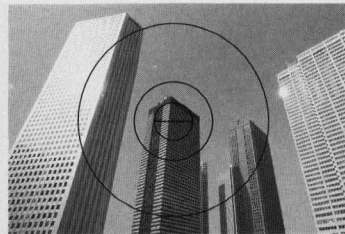

In focus

B. Microprism focusing



Out of focus



In focus

C. Matte-field focusing

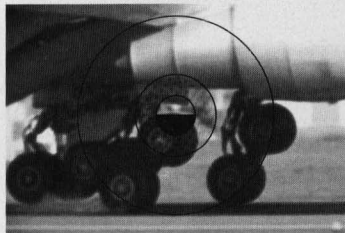

Out of focus

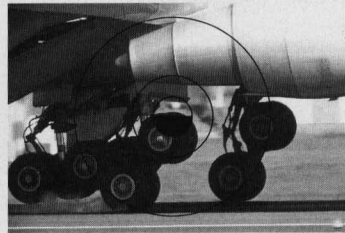

In focus

EXPOSURE

EXPOSURE METERING SYSTEMS

The Nikon N6000 provides two types of exposure metering systems – Matrix Metering and Center-Weighted Metering.

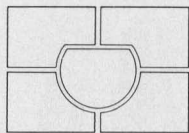

MATRIX METERING

This system is ideally suited for quick operation and for the most dependable auto exposure control. It can also be used for manual metering and flash exposure control operation with any Nikon TTL Speedlight.

In Matrix Metering, the meter automatically provides the correct exposure of the main subject in virtually any lighting situation, without requiring manual exposure compensation. The Matrix Metering sensor determines scene brightness by dividing the scene into five areas, then analyzing each area for brightness and scene contrast.

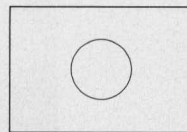

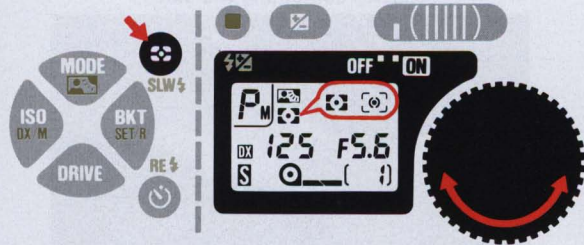

CENTER-WEIGHTED METERING

Choose Center-Weighted Metering when you want to base exposure on either auto or manual exposure control for a centrally located subject. Selecting Center-Weighted Metering overrides Matrix Metering and concentrates 75% of the meter's sensitivity into the center of the viewfinder outlined by a 12mm circle.



METERING SYSTEM SETTING

1. Slide main switch to ON.
2. While pressing metering system button, rotate command dial until your desired symbol —  for Matrix Metering or  for Center-Weighted Metering appears in LCD panel.

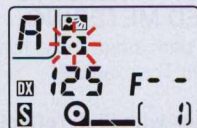

Matrix Metering is possible only with lenses that have a built-in CPU (such as AF Nikkor and AI-P lenses). When a lens without a built-in CPU or no lens is used, the metering system is automatically set to Center-Weighted. In either case, if you lightly press the shutter release button, the  symbol blinks.

METERING SYSTEM SELECTION – WHEN TO USE MATRIX OR CENTER-WEIGHTED METERING

In scenes with both very bright and very dark areas, these two metering systems produce varying results. For example:

A. Scene containing the sun or scenes with high reflectivity

If a scene contains strong highlights, such as the sun, snow or bright reflections, Center-Weighted Metering renders the main subject as a silhouette. With Matrix Metering, however, the light value of darker parts is evaluated, resulting in an overall well-balanced exposure.

B. Outdoor backlit subject

With Center-Weighted Metering, a backlit subject or scene with people against a bright sky and/or clouds may lead to an underexposed shot. With Matrix Metering, however, the camera automatically gives more exposure to darker subjects to ensure a balanced overall exposure.

C. Front-lit subject against dark background

If a brightly lit off-center subject is positioned against a dark background, Center-Weighted Metering places too much emphasis on the dark center of the picture. So although the background is correctly exposed, the main subject will be overexposed. Matrix Metering, however, automatically integrates a dark background with a bright subject to ensure the best overall exposure.

Scene containing the sun

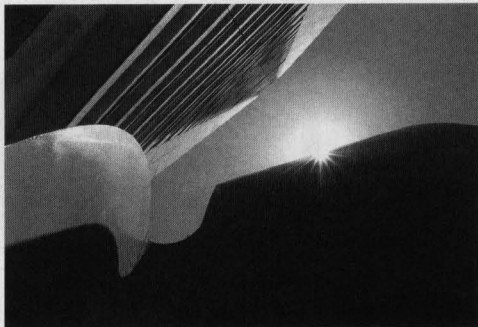

Matrix Metering



Center-Weighted Metering

Outdoor backlit subject



Matrix Metering



Center-Weighted Metering

Front-lit subject



Matrix Metering



Center-Weighted Metering

D. Small dark subjects against a bright background

A subject significantly smaller than any of the Matrix Metering sections may not be recognized and integrated into the automatic exposure evaluation. For such subjects, switch to Center-Weighted Metering and make exposure compensation with AE lock lever* or exposure compensation button** in Auto exposure mode, or obtain correct exposure meter reading on the main subject*** in Manual exposure mode.

* See pp 50 - 51

** See pp 52 - 53

*** See pp 48 - 49



Matrix Metering



Center-Weighted Metering (with AE Lock)



Center-Weighted Metering (without AE Lock)

E. Sunset scenes

If you want to emphasize a dramatic sunset but don't want Matrix Metering to lighten the scene for a dark foreground subject, use Center-Weighted Metering with or without exposure compensation.



Matrix Metering



Center-Weighted Metering

EXPOSURE MODE

Light reaching the film is controlled by the shutter and aperture. The proper combination of shutter and aperture settings results in the correct exposure. The necessary settings will be based upon the ISO speed set for the film in use and the operation of the camera's exposure control system.

The relationship between aperture and shutter is as follows:

One change in shutter speed either doubles or halves the light transmitted. For example, 1/500 passes half the light as 1/250 and double the light of 1/1000. The aperture f/8 passes half the light of f/5.6 and double the light of f/11. If the correct exposure for a scene is 1/500 at f/8, then we can also select 1/250 at f/11 or 1/1000 at f/5.6 and achieve the same exposure results.

Selecting the exposure control mode means deciding if you want the shutter speed/aperture to be set automatically or manually.

The Nikon N6000 offers five modes: four automatic exposure control modes — Auto Multi-Program (**P**), Normal-Programmed (**P**), Shutter-Priority auto (**S**), and Aperture-Priority auto (**A**) — in addition to Manual (**M**) mode.

Each exposure mode has its own advantages.

In Programmed auto exposure mode, as the optimum combination of shutter speed and aperture is automatically set by the N6000's microcomputer, you can concentrate completely on picture composition and have greater opportunities to shoot, without worrying about exposure.

In Shutter-Priority auto exposure mode, you can manually set shutter speed as desired. That is, you can freeze the action with sharp, clear images using a fast shutter speed, or create motion effects by choosing slower shutter speeds.

In Aperture-Priority auto exposure mode, you can control depth of field by varying the aperture. You can use a larger aperture (smaller f-number) for shallower depth of field to create softer, less distinct backgrounds, or choose a smaller aperture (larger f-number) for greater depth of field.

In Manual exposure mode, in addition to controlling both shutter speed and aperture, you can easily create intentionally over- or underexposed photos.

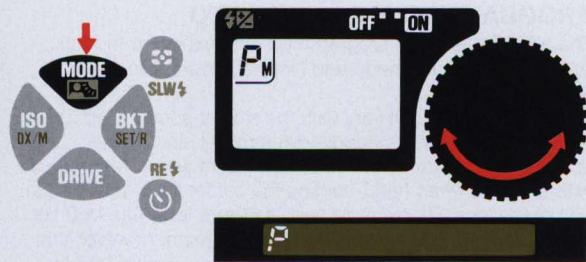

EXPOSURE MODE SETTING

After turning power switch on, while pressing MODE button, rotate command dial. Exposure mode changes in the following sequence:

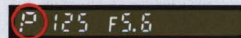
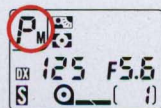

Auto Multi-Program

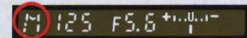
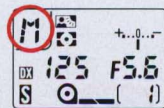

Manual

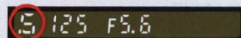
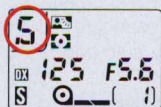

Shutter-Priority Auto

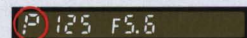
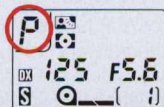

Normal Program

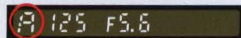
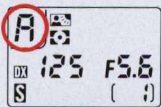

Aperture-Priority Auto

Correspondingly, P_M, S, A, M or P will appear on the LCD panel while P (for both Auto Multi-Program and Normal Program), S, A and M will appear inside viewfinder.

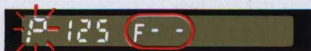
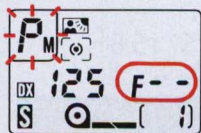

For Programmed auto or Shutter-Priority auto exposure mode, use only lenses that have a built-in CPU such as AF Nikkor or AI-P lenses. With other lenses, exposure mode is automatically set to Aperture-Priority auto and the metering system to Center-Weighted.

In this case, when you lightly press shutter release button, exposure mode indicator blinks and **F--** appears on the LCD panel.

PROGRAMMED (P_M and P) AUTO

The N6000 offers two programmed auto exposure modes: Auto Multi-Program mode and Normal Program mode.

Picture sharpness can vary with the shutter speed used. Different focal length lenses handle differently at slow shutter speeds. The recommended slowest shutter speed to be used with any lens when hand-holding the camera is 1/focal length (FL) of the lens. For example, with a 60mm lens, use 1/60 sec. as the slowest hand-held speed. Keep in mind, however, that 1/30 sec. is the lowest recommended shutter speed for blur-free hand-held shooting.

The N6000's Auto Multi-Program varies the exposure program lines according to the focal length and lens maximum aperture. The inclinations of lines in the chart are designed to reduce the possibility of picture blur by avoiding slower shutter speeds. With Normal Program, you get a standard combination of shutter speed and aperture.

Program Charts

The EV (exposure value) charts demonstrate the difference between N6000 Auto Multi-Program and Normal Program. Follow either colored line to where it intersects a diagonal line. This shows the combination of aperture (vertical line) and shutter speed (horizontal line), which will automatically be selected at each EV brightness level.

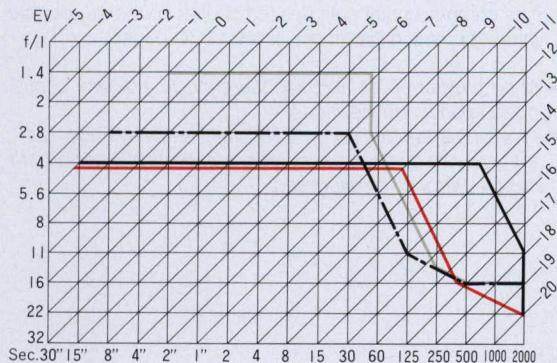

Auto Multi-Program Chart (ISO 100)

- With 50mm f/1.4
- - - With 28mm f/2.8
- With Zoom 35-135mm f/3.5-f/4.5 at 100mm setting
- With 500mm f/4

Operation in programmed auto exposure mode

Operation for Auto Multi-Program and Normal Program are performed in the same manner. See the BASIC SHOOTING on pp 16 - 19.

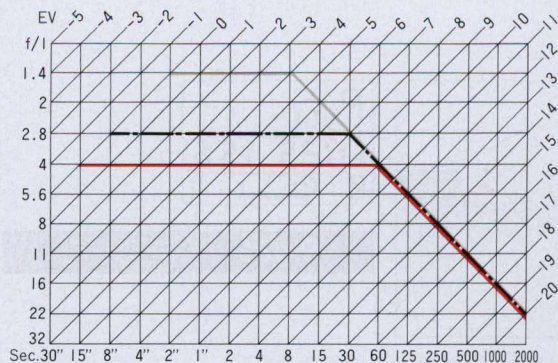

Normal Program Chart (ISO 100)

- With f/1.4 lens
- - - With f/2.8 lens
- With f/4 lens

FLEXIBLE PROGRAM

When you want to use a specific shutter speed or aperture in Programmed auto exposure mode, use the Flexible Program function. Flexible Program enables you to temporarily change an automatically set shutter speed/aperture combination in 1 EV step, while maintaining the correct exposure.

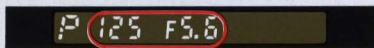
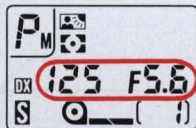
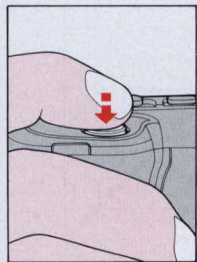

1. Lightly press shutter release button.

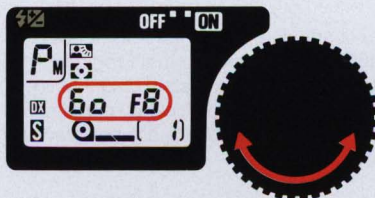

2. Turn command dial until desired shutter speed or aperture value appears in viewfinder and on LCD panel.

- When program is shifted, exposure mode indicator blinks in LCD panel and viewfinder.
- As soon as the display on LCD panel and viewfinder disappears (i.e., as soon as meter is automatically turned off), Flexible Program is cancelled.

SHUTTER-PRIORITY AUTO EXPOSURE MODE

Subject movement and your ability to hold the camera steady will determine what shutter speed you should choose. Faster speeds will generally produce sharper images. For creative effects you may use slower speeds. Make your choice accordingly. The N6000's computer automatically selects the proper aperture to match the selected shutter speed for correct exposure. Shutter-Priority auto mode operates only with Nikon lenses that have a built-in CPU (AF Nikkor and AI-P Nikkor).



At a fast shutter speed



At a slow shutter speed

OPERATION IN SHUTTER-PRIORITY AUTO EXPOSURE MODE

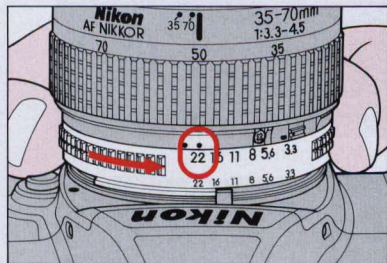

1. Set lens to its minimum aperture setting (highest f-number).
With AF Nikkor and AI-P-Nikkor lenses, lock lens aperture at minimum setting.

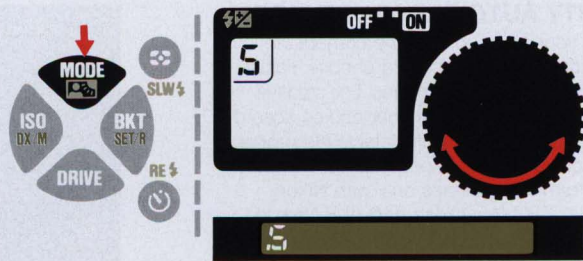

2. While pressing MODE button, rotate command dial until "S" appears on LCD panel and viewfinder.



3. Remove finger from MODE button, and rotate command dial to select desired shutter speed.
 - Shutter speed indication changes one step at a time in the following sequence:
30"-15"-8"-4"-2"-1"-2-4-8-15-30-60-125-250-500-1000-2000

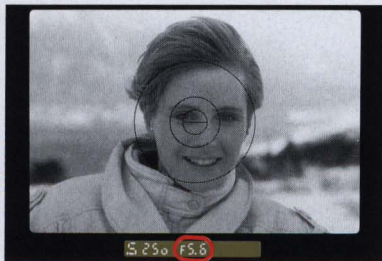

4. Confirm aperture value.
Camera selects correct aperture for shutter speed selected.

If meter has automatically turned off and LCD indicators disappear, turn meter on again by lightly pressing shutter release button.

5. Fully depress shutter release button to take the picture.

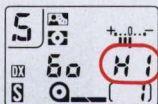

**If “HI” appears in the aperture position –
Overexposure alert*:**

Overexposure may occur. Select higher shutter speed or use Nikon ND filter.

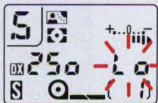

**If “Lo” blinks in the aperture position –
Underexposure alert*:**

Underexposure may occur. Select slower shutter speed, or use a Nikon Speedlight.

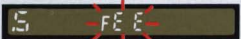

**If “FEE” blinks in the aperture position –
Lens setting error alert:**

Lens is not set to smallest aperture setting and shutter locks. Set lens to smallest aperture.

* Electronic analog display appears in both LCD panel and viewfinder to show value difference from correct exposure.

APERTURE-PRIORITY AUTO EXPOSURE MODE

Select the aperture based on how shallow or large you want depth of field to be. Smaller apertures will make the background and foreground sharper (good for scenic pictures) while larger apertures will produce a shallower depth of field (good for portraits). Your selected aperture will determine the shutter speed which is automatically set by the camera's computer. When using the smaller apertures with corresponding slower shutter speeds, remember as a rule of thumb that any speed below 1/30 sec. may require the use of a tripod to prevent picture blur due to camera shake. Also, the higher the corresponding shutter speed, the easier it is to stop action. Adjust the selected aperture if the speed is not appropriate for conditions or the specific effect you want.



At wide aperture



At small aperture

OPERATION IN APERTURE-PRIORITY AUTO EXPOSURE MODE

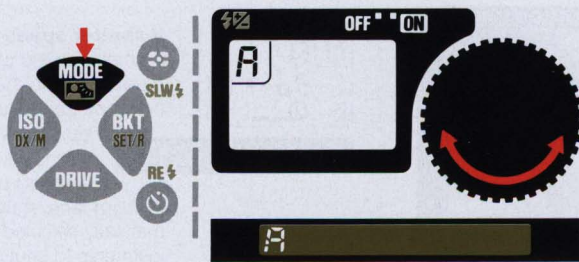

1. While pressing exposure MODE button, rotate command dial until "A" appears on the LCD panel and viewfinder.

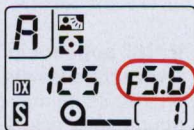
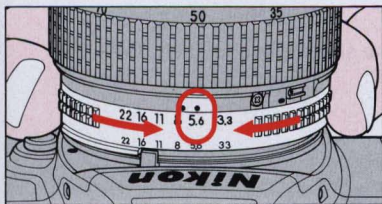

- An intermediate figure (e.g. F1.8, F3.3) displayed indicates a lens' maximum aperture. Also, with zoom lenses, the maximum aperture for different focal length settings appears in 1/6 EV steps.
- With lenses having no CPU, "F--" appears instead of aperture value on the LCD panel and viewfinder.
- With an AF Nikkor or AI-P lens, make sure to unlock aperture ring before rotating it.

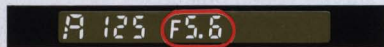

2. Remove finger from exposure mode setting button and set lens to desired f-number by rotating lens aperture ring. Aperture changes in the following sequence, as indicated in LCD panel and viewfinder.
F1-F1.4-F2-F2.8-F4-F5.6-F8-F11-F16-F22-F32-F45-F64
(Available apertures limited to those on lens in use.)



3. Confirm shutter speed.
Camera selects correct shutter speed to match your aperture setting.

If meter is automatically turned off and LCD indicators disappear, turn meter on again by lightly pressing shutter release button.

4. Fully depress shutter release button to take the picture.

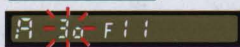
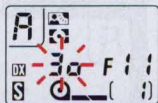

If shutter speed indicator blinks – Picture blur alert:

A shutter speed of 1/FL is generally accepted as the minimum speed for hand-held photography, but since not everyone can hold a camera equally steady, this is just a guideline. The blinking shutter speed indication warns you that the exposure conditions call for a speed of 1/FL or slower. For example, with a 200mm lens, shutter speed indication blinks when automatically selected speed is 1/200 sec. or slower. Make adjustments to shutter/aperture if that speed is inappropriate for the picture conditions.

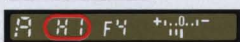
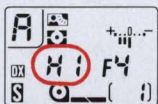

If “HI” appears in the shutter speed position – Overexposure alert*:

Overexposure may occur. Select smaller aperture (larger f-number) or use ND filter.

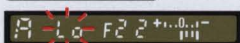
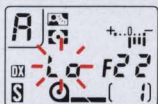

If “Lo” blinks in the shutter speed position – Underexposure alert*:

Underexposure may occur. Select wider aperture (smaller f-number), or use a Nikon Speedlight.

* Electronic analog display appears both on the LCD panel and viewfinder to show value difference from correct exposure.

MANUAL EXPOSURE MODE

Manual exposure control allows you to make both aperture and shutter speed settings. You'll probably follow the recommendation of the camera's light meter for technically correct exposure, but you may choose otherwise and modify exposure settings for creative effects or special requirements.

OPERATION IN MANUAL EXPOSURE MODE

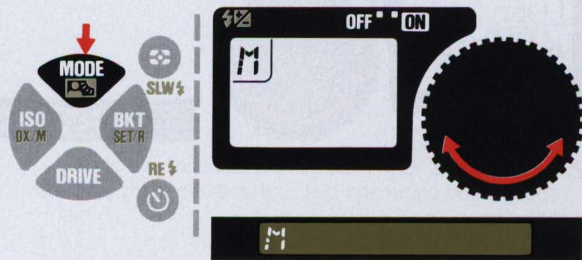

1. While pressing exposure mode button (MODE), rotate command dial until "M" appears on the LCD panel and viewfinder.

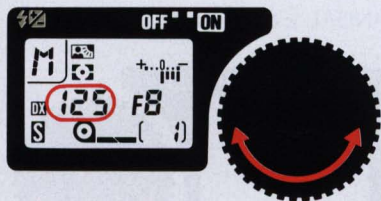

2. Remove finger from exposure mode button, set shutter speed using command dial, and aperture using lens aperture ring.

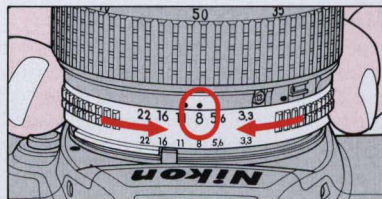
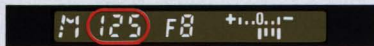

- With lenses that have no CPU, "F--" appears instead of aperture value on the LCD panel and viewfinder.

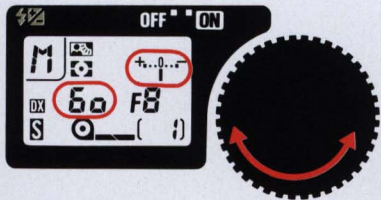

3. Adjust aperture and/or shutter speed until Electronic Analog Display indicates "0" or the desired exposure.

- With an AF Nikkor or AI-P lens, make sure to unlock aperture ring before rotating it.

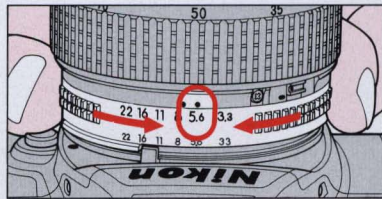

The electronic analog display range is +1EV to -1EV, in increments of 1/3EV.

◀ and ▶ appears when exposure is beyond ±1EV.

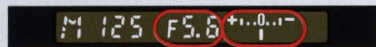
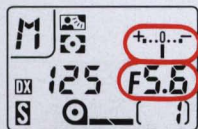
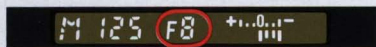
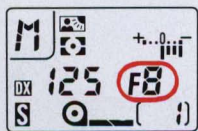

Examples:

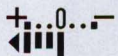

Over +1EV



$\pm 0EV$

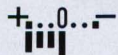

+1EV

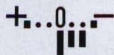

-2/3EV

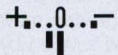

+1/3EV

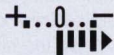

Below -1EV

If meter is automatically turned off and LCD indicators disappear, turn meter on again by lightly pressing shutter release button.

4. Fully depress shutter release button to take the picture.

TO GET EXPOSURE METER READING FOR A MAIN SUBJECT OFF CENTER

If you want to set desired exposure on a particular subject, use Center-Weighted Metering. With a subject outside the 12mm-dia. circle, or when there is a substantial difference in brightness between the main subject and the background (e.g., a strongly backlit subject), use the following manner.



1. Center main subject inside viewfinder's 12mm circle and/or move in closer so the circle is covered by the subject.

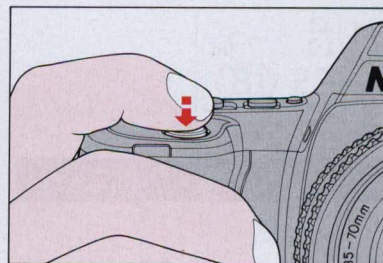

2. Lightly press shutter release button.

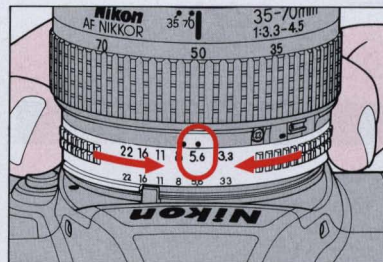
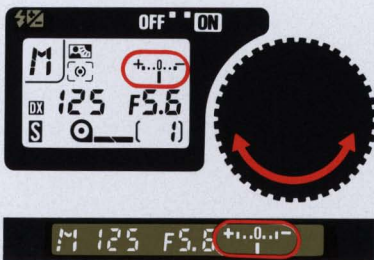

3. Adjust shutter speed and aperture until electronic analog display shows desired exposure.

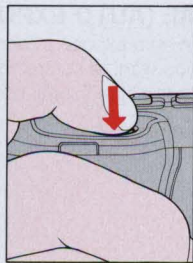

4. Recompose the picture and shoot.

BULB SETTING

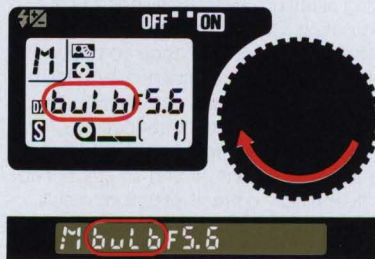

For long-time exposure, use B (bulb) setting. On bulb setting, shutter remains open as long as shutter release button remains depressed. This setting can only be used in Manual exposure mode. To select, rotate command dial clockwise until **"bulb"** appears.

- With the bulb setting, changing the exposure mode to shutter-priority auto causes **"bulb"** to blink, and shutter is locked.
- When using bulb setting, camera must be held very steady. Use a tripod and cable release.
- You can perform long-time exposure for approximately 10 hours with a fresh battery.

EXPOSURE COMPENSATION

Matrix Metering provides the main subject with correct exposure in virtually any lighting situation, without having to use manual exposure compensation. But in Center-Weighted Metering, for situations where you want to change compositions or for unusual situations such as snowscapes, backlit subjects or when the main subject contrasts sharply with the background, exposure compensation is recommended. Also, in Matrix Metering, "correct" exposure is a value based on a combination of film sensitivity, aperture and shutter speed necessary to produce a "technically correct" exposure result. We often want to vary the exposure results to create different versions of the same picture or put creative emphasis on a specific part of the picture. This is accomplished by using exposure compensation.

Exposure compensation can be accomplished in either one or a combination of the following ways.

- AE (Auto Exposure) Lock Lever
- Exposure Compensation Button
- Auto Exposure Bracketing

As the results can vary depending on conditions, you may want to experiment with each method.

AE (AUTO EXPOSURE) LOCK LEVER

In auto exposure mode with Center-Weighted Metering, when you want to control exposure based on a particular brightness area of the scene, use the AE lock lever.

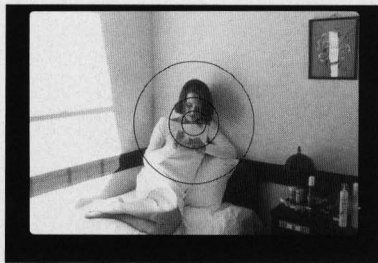

1. Center main subject inside viewfinder's 12mm circle and/or move in closer so the circle is covered by the subject.

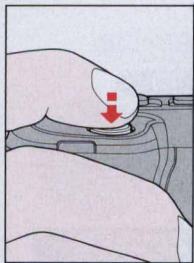

2. Lightly press shutter release button, and confirm shutter speed and aperture in viewfinder.

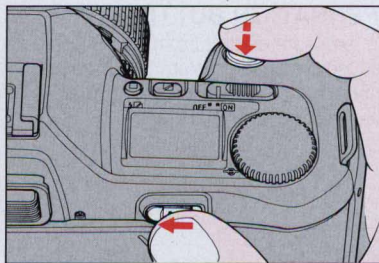

3. While lightly pressing shutter release button, slide AE lock lever and hold in.
- While AE lock lever is held in, shutter speed indication does not blink for picture-blur alert, even if a slow shutter speed is selected.

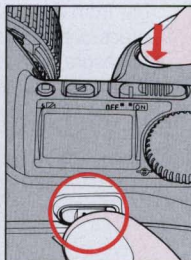

4. Recompose and shoot.

EXPOSURE COMPENSATION BUTTON

If you wish to modify the exposure control (from the ISO standard), use the Exposure Compensation system. Modification from -5EV to $+5\text{EV}$ is possible. Be sure to reset the control to zero to resume normal operation.

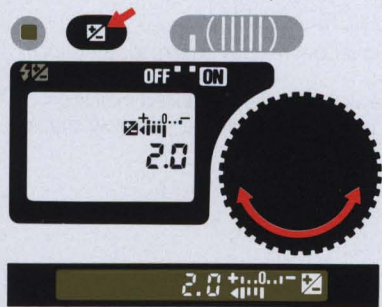

While pressing exposure compensation  button, rotate command dial to set desired compensation value. The following display appears on the LCD panel and viewfinder:

symbol



Electronic analog display with indications

from -1 to $+1$ EV in $1/3$ steps: Confirm the direction of exposure ($-$ or $+$).

Compensation value (from -5 to $+5$ EV in $1/3$ steps):

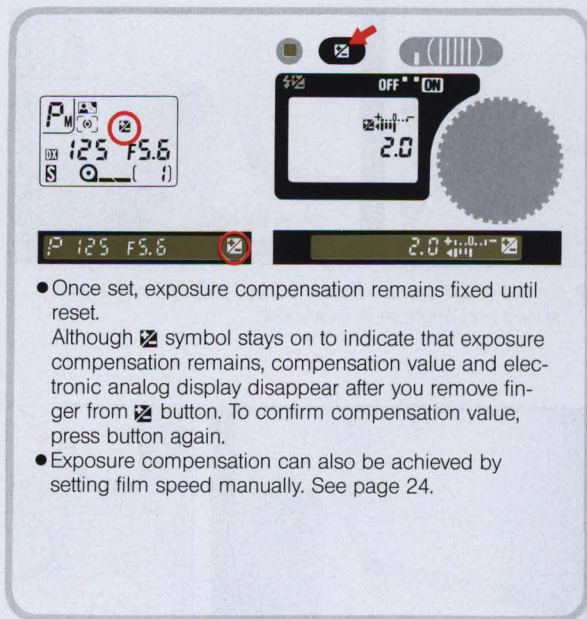
Confirm amount of exposure compensation.



- Once set, exposure compensation remains fixed until reset. Although  symbol stays on to indicate that exposure compensation remains, compensation value and electronic analog display disappear after you remove finger from  button. To confirm compensation value, press button again.
- Exposure compensation can also be achieved by setting film speed manually. See page 24.



Without compensation



+2EV compensation

Examples:

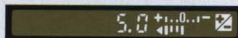
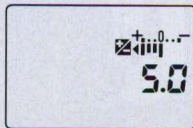

Over +1EV

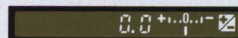
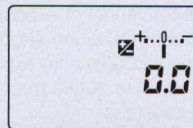

±0EV

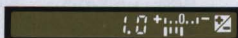
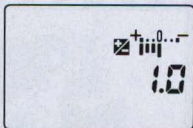

+1EV

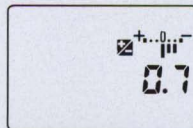

-2/3EV

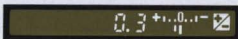
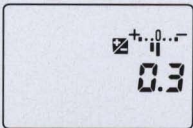

+1/3EV

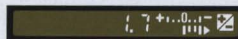
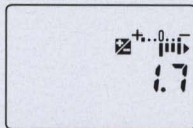

Below -1EV

AUTO EXPOSURE BRACKETING

When you want a variety of exposures of the same subject (e.g., when shooting a sunset), use the N6000's auto exposure bracketing function to obtain three or five different exposures.

Auto exposure bracketing only operates in connection with any of the auto exposure control modes.

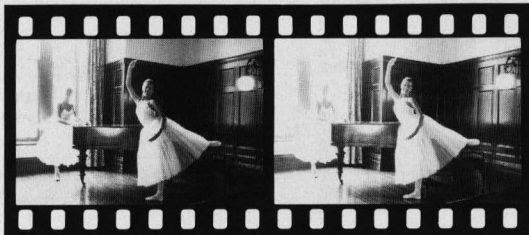

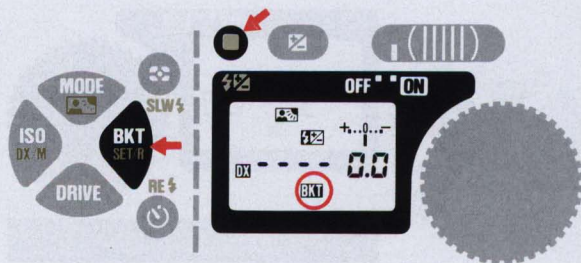
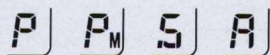
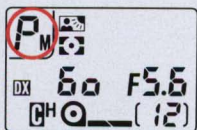

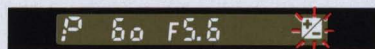

1. Set exposure mode to Programmed auto, Shutter-Priority auto or Aperture-Priority auto.

In Programmed auto exposure mode, both shutter speed and aperture will be changed for your set compensation value in stepped sequence. Aperture will be changed in Shutter-Priority auto; shutter speed will be changed in Aperture-Priority auto.



2. While pressing shift button, push BKT button to set auto exposure bracketing. Blinking **BKT*** and  marks appear on the LCD panel. Inside viewfinder,  symbol is blinking.

* **BKT** symbol remains after meter is turned off, but stops blinking.

With exposure mode set at Manual, no exposure compensation will be made but as many shots as number of frames set will be taken. With Bulb setting, shutter is locked.

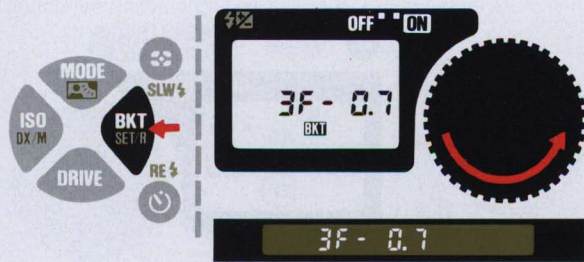



3. While pressing BKT button, rotate command dial until your desired combination of number of frames and compensation value appear on the LCD panel and viewfinder. For example, to shoot three frames with 0.7 degree compensation, set 3F-0.7.

Indication changes:

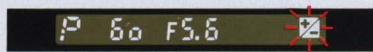
- 1F-00 (just after the BKT button is pressed)
- 3F-0.3
- 3F-0.7
- 3F-1.0
- 5F-0.3
- 5F-0.7
- 5F-1.0



4. Remove your finger from BKT button. On the LCD panel, the number of frames you set for auto exposure bracketing appears instead of normal frame counter and blinking **BKT** and  marks remain to show auto exposure bracketing is set. Inside the viewfinder,  symbol blinks. Now, exposure is compensated as you set in step 3. (Depending on compensation value you set, LCD panel and viewfinder may show exposure indication different from that shown before step 3).

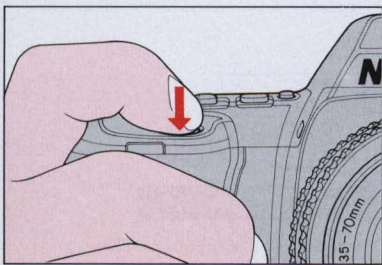

5. Depress shutter release button to release shutter and start auto exposure bracketing operation. Number of frames for auto exposure bracketing decreases each time shot is taken. For example, if you have set number of frames and compensation value as 3F-0.7, three shots — the first with -0.7 underexposed, the second without compensation and the third with $+0.7$ overexposed — will be taken.



With film advance mode set at S:

Camera takes three or five shots as set — one shot each time you depress shutter release button.

With film advance mode set at Cl or Ch:

Depressing shutter release button and holding it in triggers three or five shots as set. If you remove your finger from shutter release button before the set number of shots is taken, the operation stops. To take the remaining shots, depress and hold shutter release button again.

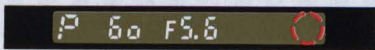
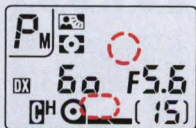

6. When all frames set are taken, **BKT** and **☒** marks disappear showing auto exposure bracketing operation completed and automatically cancelled.

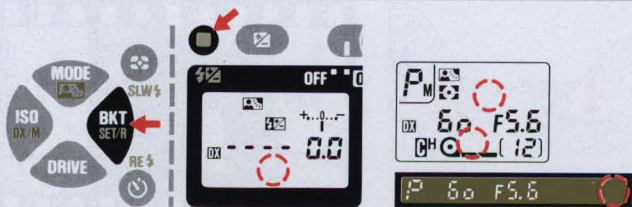

- To cancel auto exposure bracketing before or during operation, while pressing shift button, push BKT button. **BKT** and **☒** marks disappear.
- If you set auto exposure bracketing with self-timer function, auto exposure bracketing will not be performed but one shot without exposure compensation will be taken.
- Auto exposure bracketing in flash photography compensates amount of flash output regardless of camera's exposure mode.
- If film reaches end of roll during shooting, auto exposure bracketing automatically stops. After loading a new film roll, push shutter release button to resume operation.
- If auto exposure bracketing is performed with another exposure compensation on camera or Speedlight, any compensation value can be added.

SELF-TIMER OPERATION

ONE-SHOT SELF-TIMER

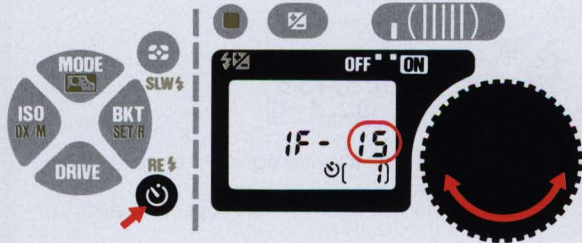



1. While pressing  button, rotate command dial until desired timer duration appears on the LCD panel. Timer duration can be selected between 2 to 30 seconds in one-second increments.

● **2F-10** for two-shot self-timer appears next to **1F-30**. For two-shot self-timer operation, see next page.

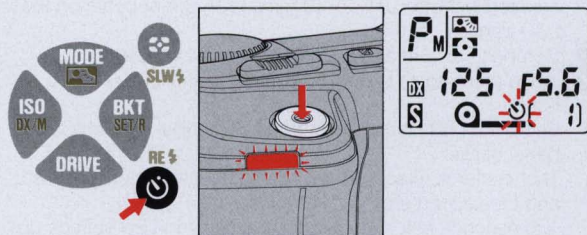

2. Compose picture and confirm focus and exposure.



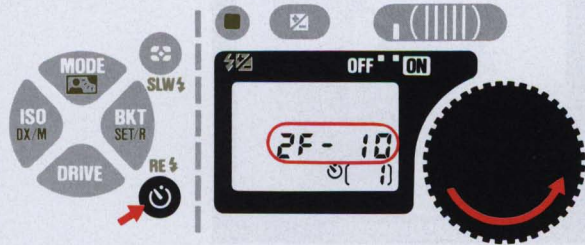

3. While pressing  button, fully depress shutter release button. Self-timer LED starts blinking and  symbol on the LCD panel blinks. For the final two seconds, the blinking LED speeds up, telling you to get ready.

TWO-SHOT SELF-TIMER



It is possible to take two consecutive self-timer pictures.

1. While pressing self-timer , rotate command dial counterclockwise until 2F-10 (next to 1F-30) appears on the LCD panel.
2. Compose picture and confirm focus and exposure.
3. While pressing , fully depress shutter release button.

Self-timer LED starts blinking and  symbol on the LCD panel blinks.

The shutter is released for the first shot after approx. 10 sec., and the second shot is taken 5 sec. later.

Two seconds before each shot, the blinking LED speeds up, telling you to get ready.

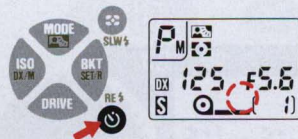

- To cancel self timer after it is activated, press  button again.
- Exposure is locked when self-timer operation starts.

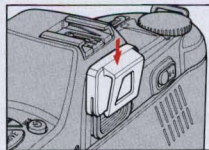

- When using any auto exposure mode, use eyepiece cover DK-5 (provided) before setting self-timer to prevent stray light from entering the viewfinder and affecting exposure.
- Regardless of film advance mode setting, continuous-frame shooting is not performed (except for two-shot self-timer operation).
- Bulb setting cannot be used for self-timer operation.

ACCESSORIES

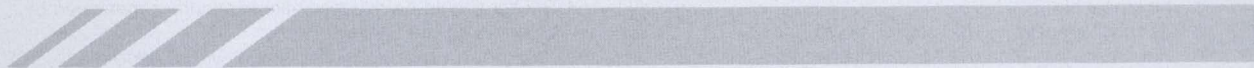

LENS COMPATIBILITY

LENS COMPATIBILITY CHART

	Exposure mode				Metering system	
	Programmed auto	Shutter-priority auto	Aperture-priority auto	Manual	Matrix	Center-Weighted
AF Nikkor lenses (except AF Nikkor lenses for F3AF)	○	○	○	○	○	○
AI-P type Nikkor ED 500mm f/4 IF	○	○	○	○	○	○
AI- or AI-S-type Nikkor lenses (including AI-modified Nikkor lenses)	×	×	○	○	×	○
Medical-Nikkor 120mm f/4 IF	×	×	×	△ ¹	×	○
Reflex Nikkor lenses	×	×	○	○	×	○
PC-Nikkor lenses	×	×	△ ²	△ ³	×	○
AI- or AI-S-type Teleconverters	×	×	○	○	×	○
Bellows Focusing Attachment PB-6	×	×	△ ⁴	△ ⁴	×	○
K Ring Set (K1~K5 rings)*	×	×	△ ⁵	△ ⁵	×	○
Auto Extension Rings (PK-11, 11A, 12, 13 and PN-11)**	×	×	○	○	×	○

* K1 ring cannot be attached to AF Nikkor lenses. The ring may damage CPU contacts. Use PK-11A or BR-6 instead.
** PK-1, PK-2, PK-3 and PN-1 rings cannot be attached to the N6000. PK-11 ring cannot be attached to AF Nikkor lenses. Those rings may damage CPU contacts. Use PK-11A for AF-Nikkor lenses instead of PK-11.

○ Compatible

× Incompatible

△¹ Set shutter speed to 1/60 sec. or slower.

△² Set preset ring, then use AE-lock lever before shifting.

△³ Set preset ring, then determine exposure before shifting.

△⁴ Shutter should be released after exposure is measured by stopping down PB-6.

△⁵ Stop-down exposure measurement will be performed.

● **The following Nikkor lenses cannot be attached to the N6000. (Camera body or lens may be damaged).**

- Non-AI lenses
- Fisheye 6mm f/5.6
- Fisheye OP 10mm f/5.6
- 200-600mm f/9.5 (No. 280001 to 301922)
- ED 180-600mm f/8 (No. 174041 to 174180)
- ED 360-1200mm f/11 (No. 174031 to 174127)
- 400mm f/5.6 and 600mm f/5.6 with Focusing Unit AU-1
- PC 28mm f/4 (No. 180900 or smaller)
- PC 35mm f/2.8 (No. 851001 to 906200)
- Reflex 1000mm f/11 (No. 142361 to 143000)
- Reflex 2000mm f/11 (No. 200111 to 200310)

● **The following teleconverter/lens cannot be used with the N6000. (Correct exposure may not be obtained using these accessories).**

- AF Teleconverter TC-16/TC-16A
- AF Nikkor 80mm f/2.8
- AF Nikkor 200mm f/3.5

ACCESSORIES

OPTIONAL SPEEDLIGHTS

Nikon Speedlights SB-24/SB-23/SB-22/SB-20

With these Speedlights, N6000 provides automatic balanced fill-flash. You can brighten shadows and balance subject and background illumination levels without complex calculations. In addition, manual flash output level adjustment, front-curtain/rear-curtain slow sync are also possible.



SB-24



SB-23



SB-22



SB-20

CLOSE-UP ACCESSORIES

For nature lovers, scientists, even general use, close-up photography provides the means to see the world in all its smaller details. The following are available for making your close-up photography even closer than the distance index engraved on your lens:

Close-Up Attachment Lenses – No. 0, 1, 2, 3T, 4T, 5T and 6T

These convenient, easy-to-use close-up attachment lenses screw directly into the front thread of the lens and magnify the image.

Numbers 0, 1 and 2 are recommended for lenses with a focal length up to 60mm. 3T and 4T work best with lenses from 85mm to 200mm; 5T and 6T with lenses from 70mm to 210mm. Numbers 5T and 6T have a front attachment size of 62mm while the rest are designed for 52mm.

For close-up attachment lenses, the higher the lens number, the closer you can focus. For the prime lens, the longer the focal length, the greater the reproduction ratio you can obtain.

Auto Extension Rings

Compact and lightweight, Nikon Auto Extension Rings offer a wide range of reproduction ratios. Models include the PK-11A, PK-12, PK-13 and PN-11. Because information on lens aperture is relayed via the PK ring to the camera, the exposure mode to use is Aperture-Priority auto or Manual.

Caution:

- PK-11, BR-4, and K1 rings cannot be used with AF-Nikkor lenses. Use PK-11A and BR-6 instead.
- K2 ring and non-AI rings (such as PK-1, PK-2, PK-3 and PN-1) cannot be used with N6000.

- PK rings do not use lens' electronic contacts. All functions related to those contacts are inoperable when using these rings.



Close-Up Attachment Lenses



Auto Extension Rings

Nikon Bellows Attachment PB-6

Mounts between the N6000 and lens for close-up and macro photography. You can vary lens extension, producing reproduction ratios from 1:1 up to 4:1 with a 50mm lens mounted normally. The lens can also be mounted in reverse to maintain aberration correction in the extreme close-up range.

The PB-6 has a stop-down lever so you can use stop-down metering. Usable exposure modes are Aperture-Priority auto and Manual.

- *When attaching the PB-6 to the N6000, set PB-6 in vertical position.*
- *Use of Double Cable Release AR-7 is recommended when using PB-6 with the N6000.*
- *PB-6 does not use the lens' electronic contacts. All functions related to those contacts are inoperable when using the PB-6.*

Micro-Nikkor Lenses – AF Micro-Nikkor 55mm f/2.8, AF Micro-Nikkor 60mm f/2.8, AF Micro-Nikkor 105mm f/2.8, Micro-Nikkor 55mm f/2.8, Micro-Nikkor 105mm f/2.8 and Micro-Nikkor 200mm f/4 IF

These specially designed lenses offer continuous focusing from infinity down to 1:1 (life size) with AF Micro-Nikkor lenses or down to 1/2x lifesize with other Micro-Nikkor lenses. The closest focusing distances are:

AF Micro-Nikkor 55mm f/2.8	0.229m (0.9 ft)
AF Micro-Nikkor 60mm f/2.8	0.219m (8 ft 3/4 in.)
AF Micro-Nikkor 105mm f/2.8	0.314m (1.0 ft)
Micro-Nikkor 55mm f/2.8	0.25m (9 ft 13/16 in.)
Micro-Nikkor 105mm f/2.8	0.41m (1.34 ft)
Micro-Nikkor 200mm f/4 IF	0.71m (2.84 ft)



PB-6



Micro-Nikkor Lenses

Note on Close-Up Photography

- In close-up photography, depth of field is generally shallow. Thus, you must stop lens aperture down as much as possible to get the greatest area of sharp focus.
- Image magnification is so high that even the slightest movement during shooting will cause a blurred image. To avoid this, use tripod with a cable release to activate the shutter.

VIEWING ACCESSORIES

Eyepiece correction lenses

To correct both near- and farsightedness, nine lenses are available from -5 to $+3$ diopter values. These values are derived from the dioptry of both the finder and the correction lens.

Eyepiece Magnifier DG-2

Provides 2x magnification of the central portion of the finder image with Eyepiece Adapter. Eyesight adjustment provided. Useful for critical focusing in close-up photography.

Nikon Eyepiece Adapter

Lets you attach the DG-2 to the eyepiece.



Eyepiece Correction Lenses



DG-2

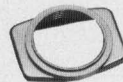

Eyepiece Adapter

OTHER ACCESSORIES

Lens Hoods

These are recommended to prevent stray light from entering the lens and causing ghost images and flare. Four types are available to match various Nikon/Nikkor lenses: snap-on, screw-in, telescopic (already incorporated into the lens), and slip-on.



Lens Hood

Filters

Nikon offers a wide selection of filters of various sizes and types to meet the needs of color and black-and-white photography. These filters work best with Nikon/Nikkor lenses. They are also useful for protecting the front of the lens, and their optical quality compliments any Nikkor optic.

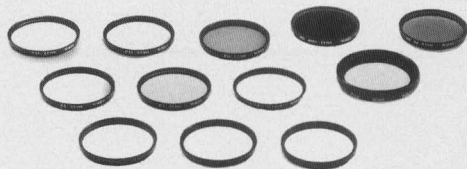

Filters

Nikon Filters

Type		Filter designation	Filter factor		Screw-in type (mm)								Drop-in type (Series IX)	Bayonet-mount type			
			Daylight	Tungsten light	39	52	62	72	77	82	95	122			160		
For Both Color and Black-and-White Film	Skylight	L1BC	1		●	●	●	●								●	
	Ultraviolet	L37C	1		●	●	●	●	●	●	●	●	●				
For Black-and-White Film	Ultraviolet	L39	1			●									●		
	Yellow	Light	Y44	1.5 (1/2)	1		●								●		
		Medium	Y48	1.7 (2/3)	1.2 (1/3)	●	●	●	●			●	●		●		●
		Deep	Y52	2 (1)	1.4 (1/2)	●	●								●		●
	Orange	O56	3.5 (1-5/6)	2 (1)	●	●	●	●			●	●		●		●	
	Red	R60	8 (3)	5 (2-1/3)	●	●	●	●			●	●		●		●	
	Green	Light	X0	2 (1)	1.7 (2/3)		●										
		Deep	X1	5 (2-1/3)	3.5 (1-5/6)		●										
For Both Color and Black-and-White Film	Soft filters	No. 1	1			●	●	●									
		No. 2	1			●	●	●									
	Circular Polarizing	C-PL	2~4 (1~2)			●	●										
	Neutral Density	ND2X	2 (1)		●												
		ND4X	4 (2)		●	●		●									
		ND8X	8 (3)		●	●											
ND400X		400 (8.6)			●												
For Color Film	Amber	Light	A2	1.2 (1/3)	●	●	●	●								●	
		Deep	A12	2 (1)	●	●	●										
	Blue	Light	B2	1.2 (1/3)	●	●	●	●									●
		Medium	B8	1.6 (2/3)	●	●											
		Deep	B12	2.2 (1-1/6)	●	●	●										

() indicates increase in f/stop.

- For lens protection the L37C is recommended.
- Do not use more than one filter at a time, or vignetting may occur. Be especially careful when using filters together with short focal-length lenses.
- When shooting a backlit subject or if there is a bright source in the frame, a ghost image is likely to result when using a filter. In this case, remove filter.

- When using a filter requiring exposure compensation such as the O56, R60, ND filter, etc., Matrix Meter performance is altered by the filter's affect on contrast; to get correct exposure, use Center-Weighted metering.
- When using R60 under tungsten light, increase the exposure value by one f/stop more than that indicated by the exposure meter.

Semi-Soft Camera Cases

Two types are available: the CF-45 for use with AF Zoom-Nikkor 35-70mm f/3.3-f/4.5 or smaller lens, and the CF-46 for AF Zoom-Nikkor 35-135mm f/3.5-f/4.5 or smaller lens.

Neckstraps

Webbed nylon neckstraps AN-4Y (yellow), AN-4B (black), and wider webbed nylon neckstraps AN-6Y (yellow), AN-6W (brown) are available.



AN-4Y



AN-6Y

MISCELLANEOUS



CAMERA CARE TIPS



1. Never touch reflex mirror or focusing screen. Remove dust with a blower brush.

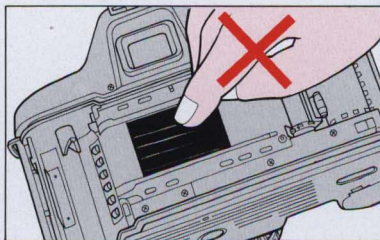

2. Never touch shutter curtains.

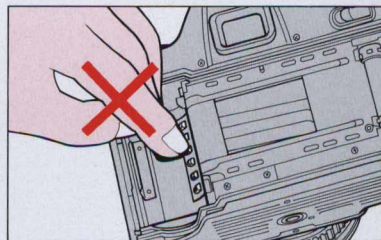

3. Never touch DX contacts. Keep clean with blower brush.

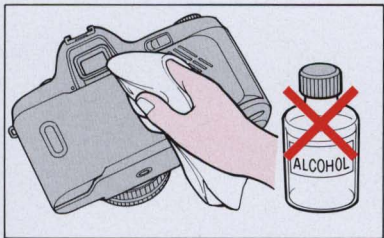

7. Clean viewfinder eyepiece and LCD panel with a soft, clean cloth. Do not use liquid cleaners.

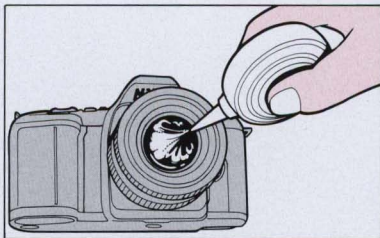

8. Clean glass surfaces such as the lens with a blower brush; avoid using lens tissue as much as possible. To remove dirt and smudges, use soft lens tissue slightly moistened with lens cleaner. Wipe in a spiral motion

from center to periphery being careful not to leave traces.

Caution!

Be very careful when using a spray can-type blower. If the can comes into contact with the camera or lens, it could seriously damage the equipment. The can should be placed on a table and the lens should be passed through the air jet no closer than about 30cm (20 inches) from the air nozzle. *Never invert, shake or move the can when using it.*

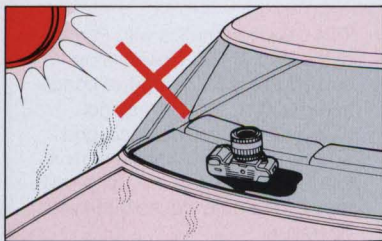

4. Do not leave camera in a hot place.

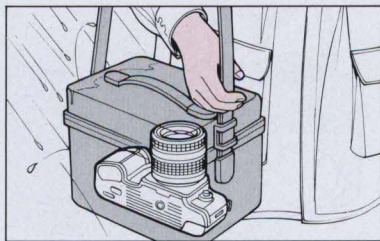

5. Keep camera away from water or moisture. When using camera near water, guard against splashes, especially salt water spray.



6. If camera malfunctions, take it immediately to an authorized Nikon dealer or service center.

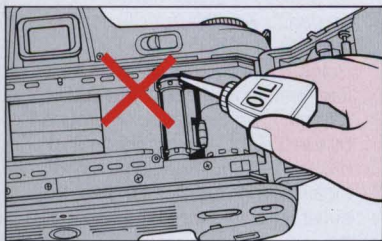

9. Do not lubricate the camera.

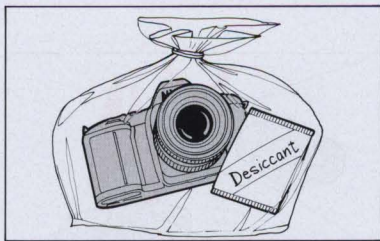

10. Store camera in a cool, dry place away from naphthalene or camphor (moth repellents). In a humid environment, store camera inside a vinyl bag with a desiccant to keep out dust, moisture and salt.

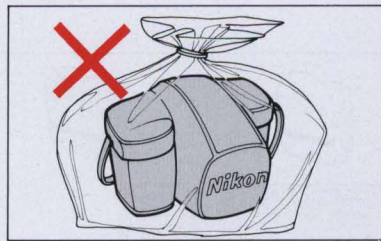

Note, however, that storing the leather case in a vinyl bag may cause leather to deteriorate.

NOTES ON BATTERIES

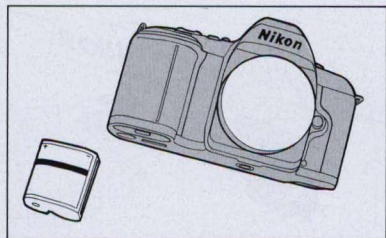

- 1.** When not using camera for a long period, remove battery.



- 2.** Battery power drains off in extremely cold temperatures – make sure battery is new and keep camera body wrapped in something warm.

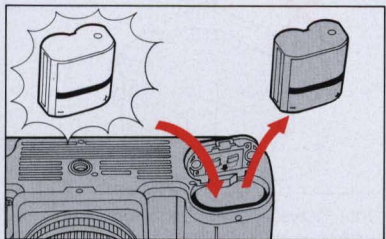

- 3.** When replacing battery, be sure to use fresh battery.

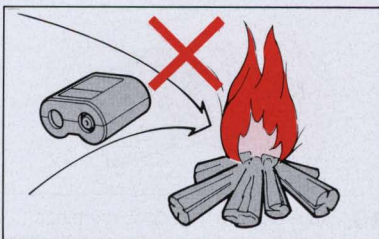

- 4.** Do not throw used batteries into a fire.

This device complies with Part 15 of the FCC Rules. Operation is subject to the following two conditions: (1) This device may not cause harmful interference, and (2) this device must accept any interference received, including interference that may cause undesired operation.

"This equipment has been tested and found to comply with the limits for a Class B digital device in accordance with the specifications set forth in Part 15 of the FCC Rules. If this equipment does cause interference to radio or television reception which can be determined by turning the equipment on and off, use the equipment in another location and/or utilize an electrical outlet different from that used by the receiver."

SPECIFICATIONS

Type of camera	Integral-motor 35mm single-lens reflex	Manual exposure control	Both aperture and shutter speed are set manually
Picture format	24mm x 36mm (standard 35mm film format)	Exposure compensation	Possible using exposure compensation button within ± 5 EV range in 1/3EV steps
Lens mount	Nikon F mount	Auto exposure lock	Available by sliding the AE lock lever while the meter is on
Lens	Nikkor lenses having CPU contacts, AI-S-type Nikkor lenses*, AI-Nikkor lenses* and AI-modified Nikkor lenses* <i>*With limitation. See chart on page 62.</i>	Auto exposure bracketing	3 or 5 frames can be taken of the same subject using a variety of exposures (with compensation degree of 0.3, 0.7 or 1 EV between each frame)
Exposure metering	Two types of exposure metering systems — Matrix metering and Center-Weighted metering	Shutter	Electromagnetically controlled vertical-travel focal-plane shutter
Metering range	EV 0 to EV 19 at ISO 100 with f/1.4 lens	Shutter release	Electromagnetic type
Exposure meter	Activated by powering the camera on or by lightly pressing shutter release button; stays on for approx. 16 sec. after lifting finger from button	Shutter speeds	Lithium niobate oscillator-controlled speeds from 1/2000 to 30 sec.; stepless in Programmed auto and Aperture-Priority auto exposure modes; one EV steps in Shutter-Priority auto and Manual exposure modes; Electromagnetically controlled long exposure at B setting
Exposure modes	Programmed auto (P _M , P), Shutter-Priority auto (S), Aperture-Priority auto (A) and Manual (M) modes	Viewfinder	Fixed eyelevel pentaprism high-eyepoint type; 0.75X magnification with 50mm lens at infinity; 92% frame coverage
Programmed auto exposure control	Both shutter speed and aperture are set automatically; Flexible Program in one EV step increments possible	Eyepoint eyepiece cover	Approx. 18mm Model DK-5 (provided) prevents stray light from entering viewfinder
Shutter-priority auto exposure control	Aperture automatically selected to match manually set shutter speed		
Aperture-priority auto exposure control	Shutter speed automatically selected to match manually selected aperture		

Focusing screen	Fixed Nikon Type K screen with central split-image rangefinder circle, microprism collar and matte/Fresnel outer field; 12mm-dia. reference circle denotes Center-Weighted metering area	Automatic Balanced Fill-Flash Manual flash light output compensation Flash ready-light	Possible with Nikon-dedicated Speedlights such as SB-24, SB-23, SB-22, SB-20, SB-18 and SB-16B Can be controlled from +1EV to -3EV in 1/3 step increments
Film speed range	ISO 25 to ISO 5000 for DX-coded film; ISO 6 to ISO 6400 for manual setting		
Film speed setting	Auto for DX-coded films and manual setting available		
Self-timer	Electronically controlled; timer duration can be selected between 2 to 30 sec. in one sec. increments; blinking LED indicates self-timer operation; two-shot self-timer is possible; can cancel at any time	Accessory shoe	Viewfinder LED lights up when Nikon-dedicated Speedlight is ready to fire; blinks to alert poor camera/speedlight connection or insufficient light for correct exposure Standard ISO-type hot-shoe contact; ready-light contact, TTL flash contact, monitor contact
Reflex mirror	Automatic, instant-return type	Film loading	Film automatically advances to first frame when shutter release button is depressed once
Flash sync control	Normal sync, slow sync and rear-curtain sync provided	Film advance	In S (Single-frame) shooting mode, film automatically advances one frame when shutter is released; in C _H (Continuous High) or C _L (Continuous Low) shooting mode, shots are taken as long as shutter release button is depressed; in C _H mode, shooting speed is approx. 2.0fps, and in C _L , approx. 1.2fps
Flash synchronization	In Programmed auto or Aperture-Priority auto shutter operates 1/125 to 1/60 sec. {or 1/(focal length) in use at lens focal length less than 60mm} in normal sync or 1/125 to 30 sec. in slow sync; in Shutter-Priority auto or Manual exposure mode, shutter fires at speed set, and when set from 1/250 to 1/2000 sec., shutter is automatically set to 1/125 sec.		

Number of film rolls per fresh battery*

	at 20°C (68°F)	at -10°C (14°F)
With 36-exposure film rolls	approx. 140	approx. 80
With 24-exposure film rolls	approx. 210	approx. 120

*At 1/125 sec. or faster shutter speed

Frame counter

Additive type; counts back while film is rewinding

Film rewind

Automatically rewinds by sliding film rewind lever while pressing film rewind button; approx. 25 sec. per 36-exposure film roll or 17 sec. per 24-exposure film roll; stops automatically when film is rewound

Camera back

Hinged back; unchangeable

Power source

6V lithium battery pack (Duracell DL-223A/Panasonic CR-P2 or equivalent)

Checking battery power

Battery power is sufficient if shutter speed and aperture indications appear on the LCD panel and viewfinder by turning camera on or by lightly pressing shutter release button, and remain on for approx. 16 sec. after finger is removed from the button; battery power is insufficient if these indications turn off immediately after finger is removed from the button; if LCD blinks and

shutter does not operate, batteries are exhausted or improperly loaded

Dimensions (WxHxD) 154.5 x 96 x 65mm or 6.1 x 3.8 x 2.6 in.

Weight Approx. 565g or 19.9 oz. (without battery pack)

All specifications apply when using fresh lithium battery pack at normal temperature (20°C or 68°F). Specifications and designs are subject to change without notice.

GLOSSARY

Balanced fill-flash operation

A method of flash photography which keeps flash brightness in balance with the ambient light. N6000 provides automatic balanced fill-flash operation with Nikon-dedicated TTL controlled Speedlights.

Center-Weighted metering

An SLR light meter, invented by Nikon, which concentrates its sensitivity on the center portion of the camera's viewing areas.

CPU

Central Processing Unit. The electronic component which controls equipment functions.

AF Nikkor and AI-P-Nikkor lenses have a built-in CPU.

Depth of field

The zone of acceptable sharpness in front of and behind the subject on which the lens is focused.

DX code

Film information code printed on the film cartridge. The N6000, set at auto film speed setting mode, automatically senses the film speed (ISO 25 to 5000) of DX-coded film the instant it is loaded.

EV

Exposure Value. A number representing the available combinations of shutter speed and aperture that give the same exposure effect when the scene brightness and ISO remain the same.

At ISO 100, the combination of a one-second shutter speed

and an aperture of $f/1.4$ is defined as EV1.

The camera's meter may be used only within EV range of the exposure meter. For example, with the N6000, exposure metering range is from EV0-EV19 at ISO 100 with $f/1.4$ lens.

Exposure compensation

Exposure compensation for available light is performed by changing shutter speed and/or aperture via auto exposure lock lever, exposure compensation button or auto exposure bracketing.

In flash photography with a Nikon-dedicated TTL Speedlight, exposure compensation is also performed by varying the amount of flash light output.

Exposure compensation made on camera affects both foreground subject and background while varying flash output amount affects only foreground.

Exposure control

Programmed auto: Camera controls both shutter speed and aperture for correct exposure.

Shutter-priority auto: User selects shutter speed and camera chooses aperture for correct exposure.

Aperture-priority auto: User selects aperture and camera chooses shutter speed for correct exposure.

Manual: User select both shutter speed and aperture with the meter's recommendations for correct exposure.

Fill-flash

A method of flash photography which combines flash illumination and ambient light, but does not necessarily attempt to balance the two types of illumination.

Flash synchronization

The timing of the flash so it fires coincident with the operation of the camera's shutter. There are two types of synchronization: Normal Sync which fires the flash at the start of the exposure, and Rear Sync which fires the flash at the end of the exposure.

f-number

Number which indicates brightness of film plane image. Increasing/decreasing f-number is opening/stopping down lens aperture. The f-number series is equivalent to 1.4, 2, 2.8, 4, 5.6, 8, 11, 16, 22, 32, etc. Changing one step to the next larger number (i.e., from f/11 to f/16) decreases image brightness by 1/2; moving to nearest lower number doubles the brightness.

Guide number

The number given to a flash bulb or electronic flash unit to indicate its power. A guide number may be quoted in meters or feet, and depends on the speed of the film being used. Guide numbers quoted assuming a relatively efficient reflector surrounds the flash source, e.g., an average-sized room.

ISO film speed

The international standard for representing film sensitivity (speed with which it reacts to light). The higher the number, the greater the sensitivity, and vice versa. A film speed of ISO 200 is twice as fast as ISO 100, and half the speed of ISO 400 film.

LCD

Liquid Crystal Display. For the N6000, used on the panel on top of camera body and inside viewfinder.

Manual flash

Flash output is fixed in manual flash mode, while flash output power varies according to selected aperture in auto flash mode. Some Speedlights including SB-20 and SB-24 provide selectable manual output (full, 1/2, 1/4, 1/8, 1/16, etc.) and some provide full output only.

Matrix metering system

An advanced camera light metering system using a multi-segment sensor and computer; available in Nikon SLR models F-601/N6006, F-601M/N6000, F4 and F-801/N8008. A basic version is used with the Nikon F401/N4004 and F401s/N4004s models. Matrix metering is an exclusive Nikon feature.

Non-TTL auto flash

A sensor measures illumination without viewing through camera's lens.

SLR

Single Lens Reflex. A type of camera in which you look through the camera's lens as you view through the camera finder. Other camera functions, such as light metering and flash control, also operate through the camera's lens.

TTL

Through-The-Lens. Most SLR cameras have built-in meters which measure light after it has passed through the lens, a feature that enables exposure readings to be taken from the actual image about to be recorded on film, whatever the lens' angle of view and regardless of whether a filter is used.





TTL auto flash

The camera's light sensor measures flash light, as reflected by the subject on the film and shuts off the flash when measurement indicates correct exposure. Because the sensor that controls the flash receives light through the lens, TTL auto flash can be used for bounce photography, fill-in flash, multiple flash photography, etc. An additional advantage of TTL auto flash is that you can use a wide range of aperture settings, while ensuring correct exposure.

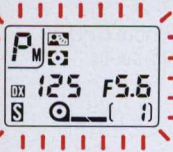
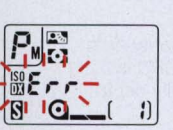
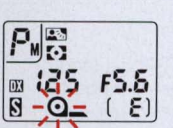

In certain cases, due to static electricity or poorly loaded battery, the N6000's microcomputer may turn the camera off, even with fresh, properly installed battery. For the same reason, film may not advance properly. In each of these cases, to resume operation, simply turn the power OFF and turn ON again, or remove battery and install again.

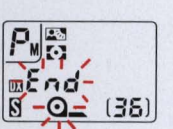
Nikon cannot be held responsible for any malfunction resulting from the use of the camera other than as specified in this manual.

WARNING INDICATIONS

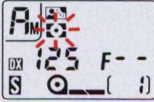
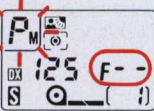
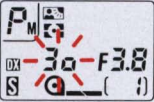
LCD panel	Shutter	Cause and remedy
 <p>All indicators shown blink</p>	Locks	Battery power is insufficient. Replace with a fresh battery pack.
 <p>Err, ISO and DX marks blink</p>	Locks	Non-DX-coded film or film with an unacceptable DX code is loaded. Set manually to the correct setting.
 <p> blinks</p>	Locks	Film is not correctly positioned. Reload film.
 <p>End and  blink</p>	Locks	Film reaches end of roll. Rewind film.

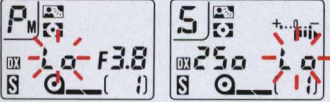
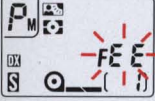
LCD panel	Shutter	Cause and remedy
 <p>M blinks</p>	Can be released	You set Matrix metering though a lens without CPU is attached. Metering system is automatically set to Center-Weighted metering.
 <p>P_M, P or S blink and F-- appears</p>	Can be released	You set programmed auto or shutter-priority auto exposure mode though a lens without CPU is attached. Exposure mode is automatically set to aperture-priority auto.
 <p>Shutter speed indicator blinks in programmed auto or aperture-priority auto exposure mode</p>	Can be released	Automatically selected shutter speed is 1/(focal length) or slower and picture blur may occur. Use a tripod to avoid camera shake, or use a Nikon Speedlight.

LCD panel	Shutter	Cause and remedy
 <p>The image shows two LCD panels. The left panel is in Program mode (P) with aperture F2.2 and shutter speed 1/100. The right panel is in Shutter Priority mode (S) with shutter speed 60 and aperture F2.2. In both panels, the letters 'HI' are circled in red, indicating high exposure warning.</p>	<p>HI appears in auto exposure mode</p> <p>Can be released</p>	<p>Overexposure may occur.</p>
 <p>The image shows two LCD panels. The left panel is in Program mode (P) with aperture F3.8 and shutter speed 1/100. The right panel is in Shutter Priority mode (S) with shutter speed 250 and aperture F3.8. In both panels, the letters 'Lo' are circled in red, indicating low exposure warning.</p>	<p>Lo blinks in auto exposure mode</p> <p>Can be released</p>	<p>Underexposure may occur.</p>
 <p>The image shows the LCD panel in Program mode (P) with aperture F2.2 and shutter speed 1/100. The letters 'FEE' are circled in red, indicating lens error.</p>	<p>FEE blinks in programmed auto or shutter-priority auto exposure mode</p> <p>Locks</p>	<p>Lens is not set to smallest aperture setting. Set lens to smallest aperture.</p>
 <p>The image shows the LCD panel in Shutter Priority mode (S) with shutter speed 1/100 and aperture F2.2. The letters 'buLb' are circled in red, indicating bulb mode warning.</p>	<p>buLb blinks</p> <p>Locks</p>	<p>Bulb is set in shutter-priority auto exposure mode. Set shutter speed to proper one or set exposure mode to manual.</p>

No reproduction in any form of this manual, in whole or in part (except for brief quotation in critical articles or reviews), may be made without written authorization from NIKON CORPORATION.

Nikon

NIKON CORPORATION

FUJI BLDG., 2-3, MARUNOUCHI 3-CHOME, CHIYODA-KU, TOKYO 100, JAPAN

PHONE: 81-3-214-5311 **TELEX:** J22601 (NIKON) **FAX:** 81-3-201-5856

IF "Err" BLINKS ON THE LCD PANEL:

During film advance

If the camera detects a malfunction with the film transport function, film advance stops and **Err** blinks in the LCD panel. When this occurs, remove your finger from the shutter release button, then fully depress the shutter release button and confirm that **Err** disappears.

When you press film rewind button to rewind film

If the camera detects a malfunction, **Err** blinks in the LCD panel. When this occurs, remove your finger from the button, then try to rewind film again.